

P2
TECHNICAL
REPORT

ARCH 493 / ARCH 473

JUNE 27TH, 2019

NATHANAEL SCHEFFLER

20561551

Energy Report Summary

Project Designer

Nathanael Scheffler

Student ID Number

20561551

Total Net Floor Area 1461 m²
 Total Net Pool Area 664 m²
 Total Gross Floor Area 1826 m²
 Total Gross Floor Area with Pool Area 2490 m²

Window-to-Wall Ratio 0.69
 Floor Area to Enclosure Ratio 0.77
 Surface Area to Volume Ratio 0.27
 Window Spec: U-value = 3.78 SHGC = 0.5
 Daylight Fraction 0.04

Estimated Total Annual Building Energy Use 294384 kWh

Energy Use by End-Use

Space Heating 56013 kWh
 Space Cooling 34084 kWh
 Ventilation 13630 kWh
 Water Heating (Building) 28684 kWh
 Plug and Process 16120 kWh
 Lighting 145854 kWh

Estimated Total Annual Pool Energy Use 106291 kWh

Estimated Renewable Energy Generation 0 kWh

Energy Use by End-Use Table

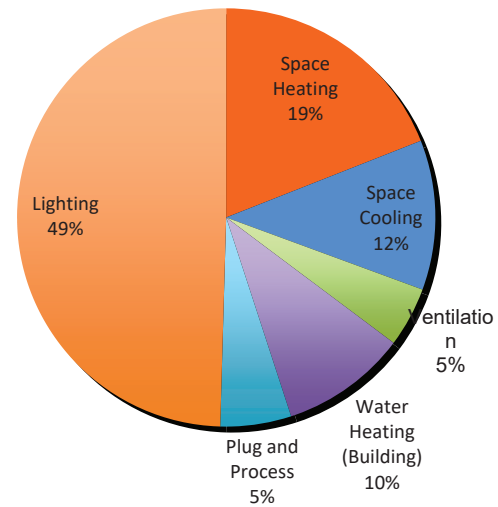

Energy Use Intensity (EUI) 161 kWh/m²/year

EUI with Pool 161 kWh/m²/year

Estimated Global Warming Potential

Nitrogen oxides (NO_x) 87 kg
 Sulphur dioxide (SO₂) 198 kg
 Carbon dioxide (CO₂) 47193 kg
 Equivalent to CO₂ emissions from 92.9 cars

Building Energy Use Intensity Comparisons

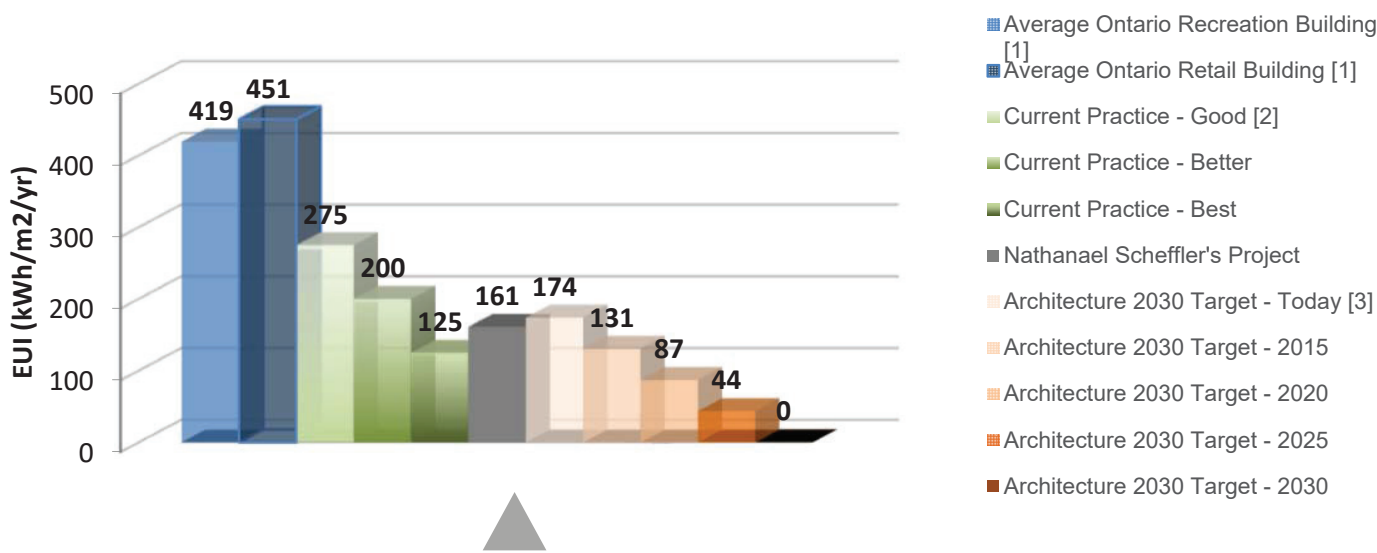

Notes:

[1] EUI Averages from ENERGYSTAR Portfolio Manager "Canadian Energy Use Intensity by Property Type" (Sept 2014), which uses Natural Resources Canada "Commercial and Institutional Building Energy Use Survey 2000"

[2] EUI for Good, Better and Best Current Practice is based on current experience for this building type

[3] More information about the Architecture 2030 Challenge can be found at <http://architecture2030.org/>

COMING FROM P1

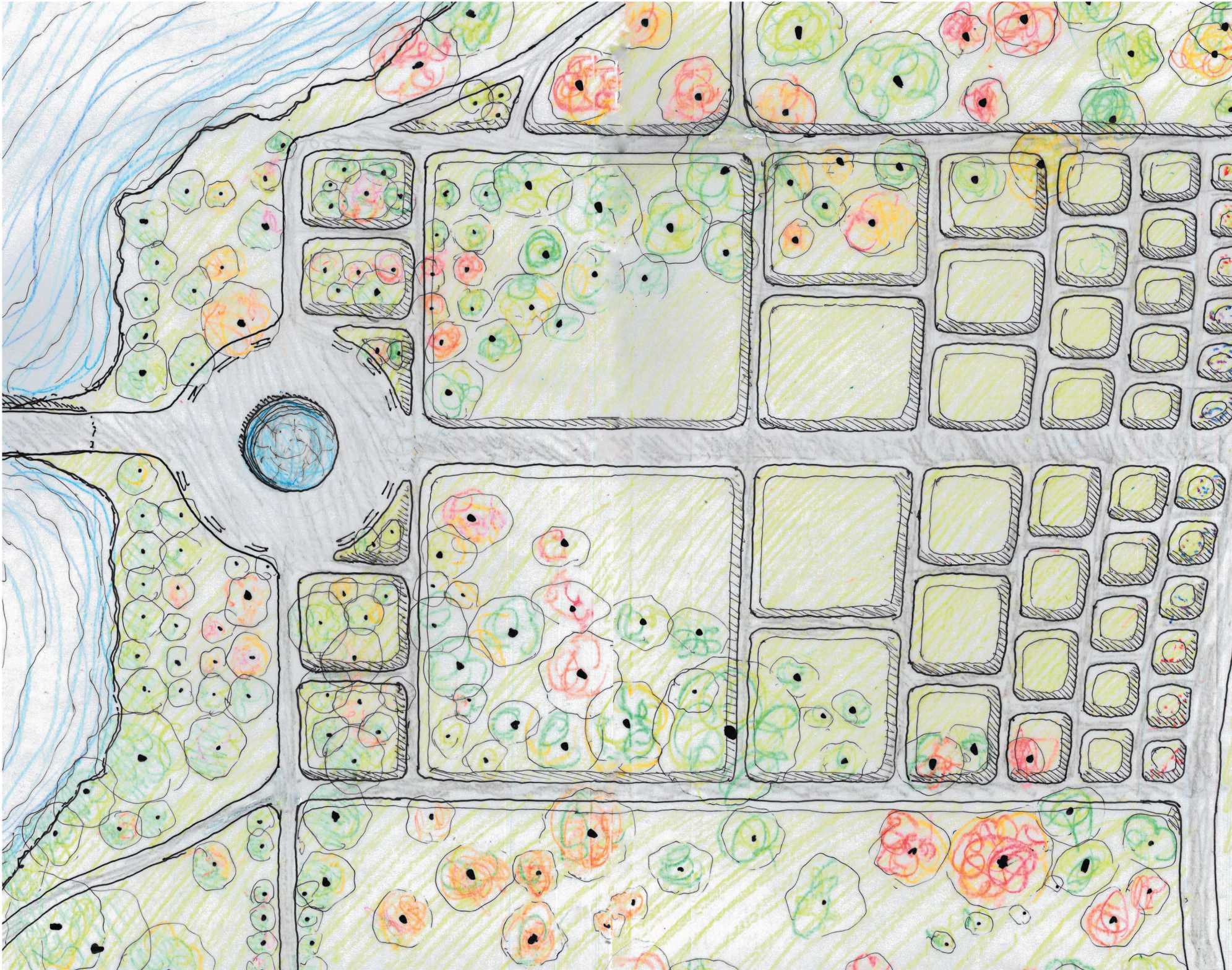

The project is located on Site B, at the end of the Avenue of the Island. At the end of P1, the project had formed most of its mass towards the lake side of the site, underneath a transplanted sand dune, imagined to be similar to those from Lake Huron, but at a larger scale. Not only is this dune proposed to assist the efficiency of the building by providing an insulating layer around it, it also aims to help create a new ecosystem, particularly supporting bees, birds, and pollinators to help keep Toronto Island beautiful and ecologically diverse.



As well as the dune, the majority of the rest of the site has been sculpted to form a segmented field, parted by a series of burms. These aim to help the site undergo sequential flooding, rather than catastrophic flooding. This allows the site to remain in use all year round, and creates small programmable areas within the larger space.

The building form was becoming problematic by the end of P1, so it has been updated for P2, as is shown in the following drawings.

OVERVIEW

Residence

Year Round
Program Cluster

[Community Centre
and Cafe Program]

Combined Central
Entry and Services

Seasonal
Program Cluster

[Toronto Island
Pools]

SCALE: 1/400
0 1 2 3 4 5 10m

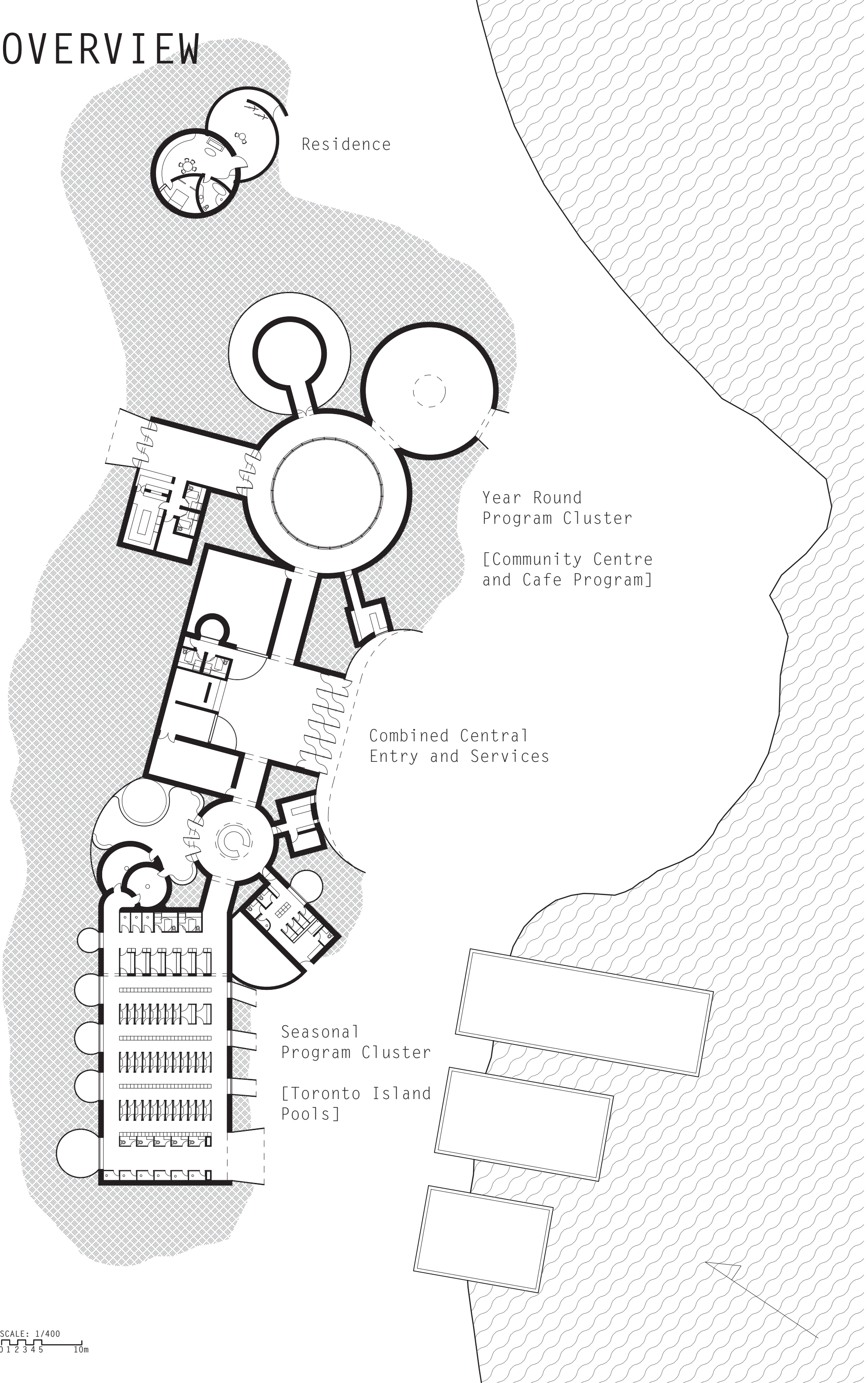

The new building still sits inside of the sand dune, and receives the same benefit of the additional insulation. The North side is very enclosed, while the South side opens up to take advantage of the Winter sun. This means that the building can have slightly less requirement for the high embodied spray foam that is used to insulate it.

The building has also been amalgamated into one cluster, rather than the two that were present in P1. However, the program is still sorted by whether it will be available all year round or seasonally, allowing a large portion of the unused space to be closed off for the winter months.

Additional systems of daylighting have been added that weren't used in P1, namely carving out exterior gardens that come down to the level of the building below the dune. These allow views, and mean that visitors can see daylight down the building's axis at almost any point in the plan.

As of now, the pools haven't been designed, however stand in pools have been placed to allow for the completion of P2. In P3, I plan to further explore how I can better integrate these pools into the scheme of the building, perhaps through pulling them into the dune in a similar manner to the hot tub.

P2

TECHNICAL
REPORT

ARCH 493 / ARCH 473

JUNE 27TH, 2019

NATHANAEL SCHEFFLER

20561551

COMFORT
STRATEGIES

PROGRAM

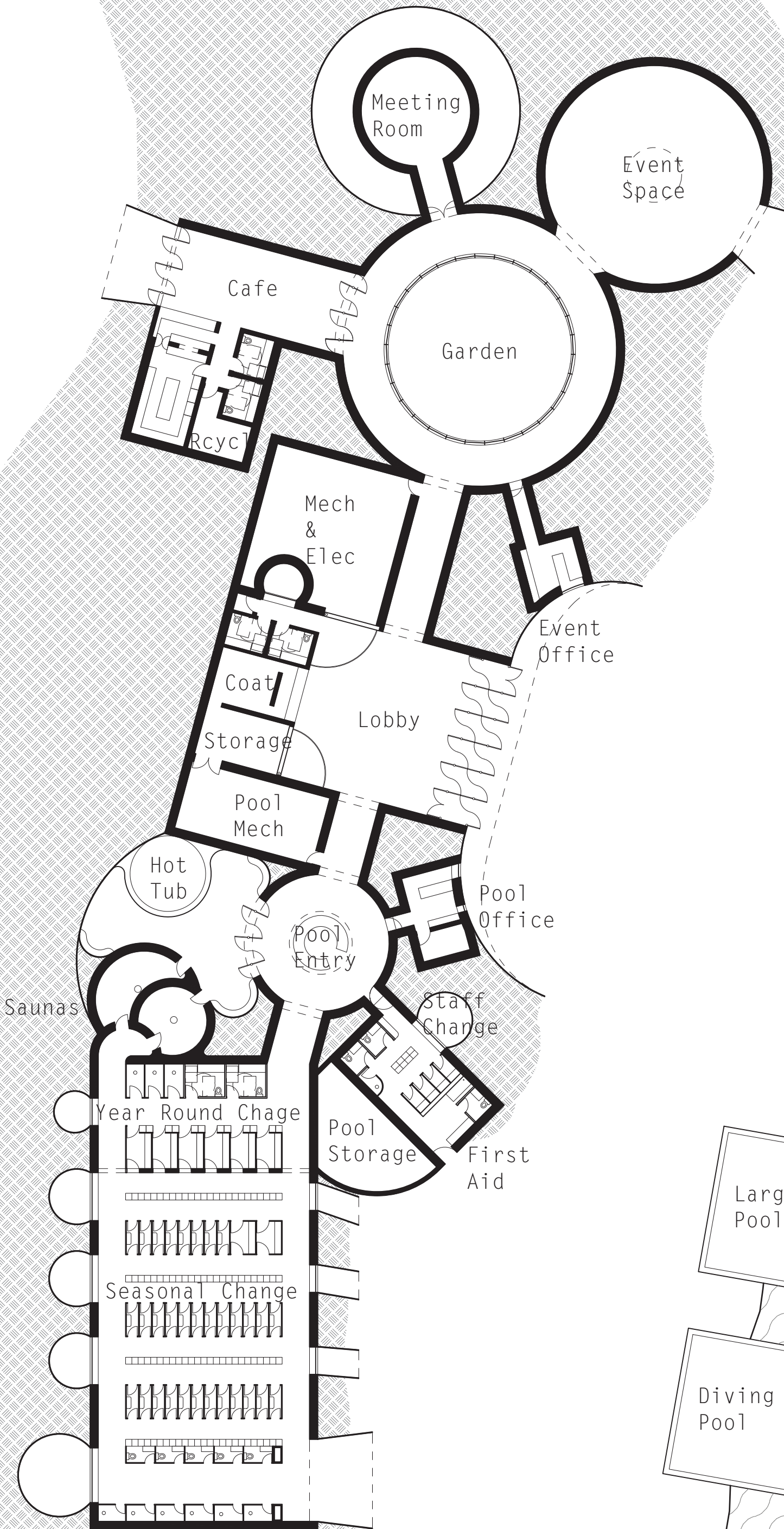

SCALE: 1/300
0 1 2 3 4 5 10m

ENVIRONMENTAL ZONES

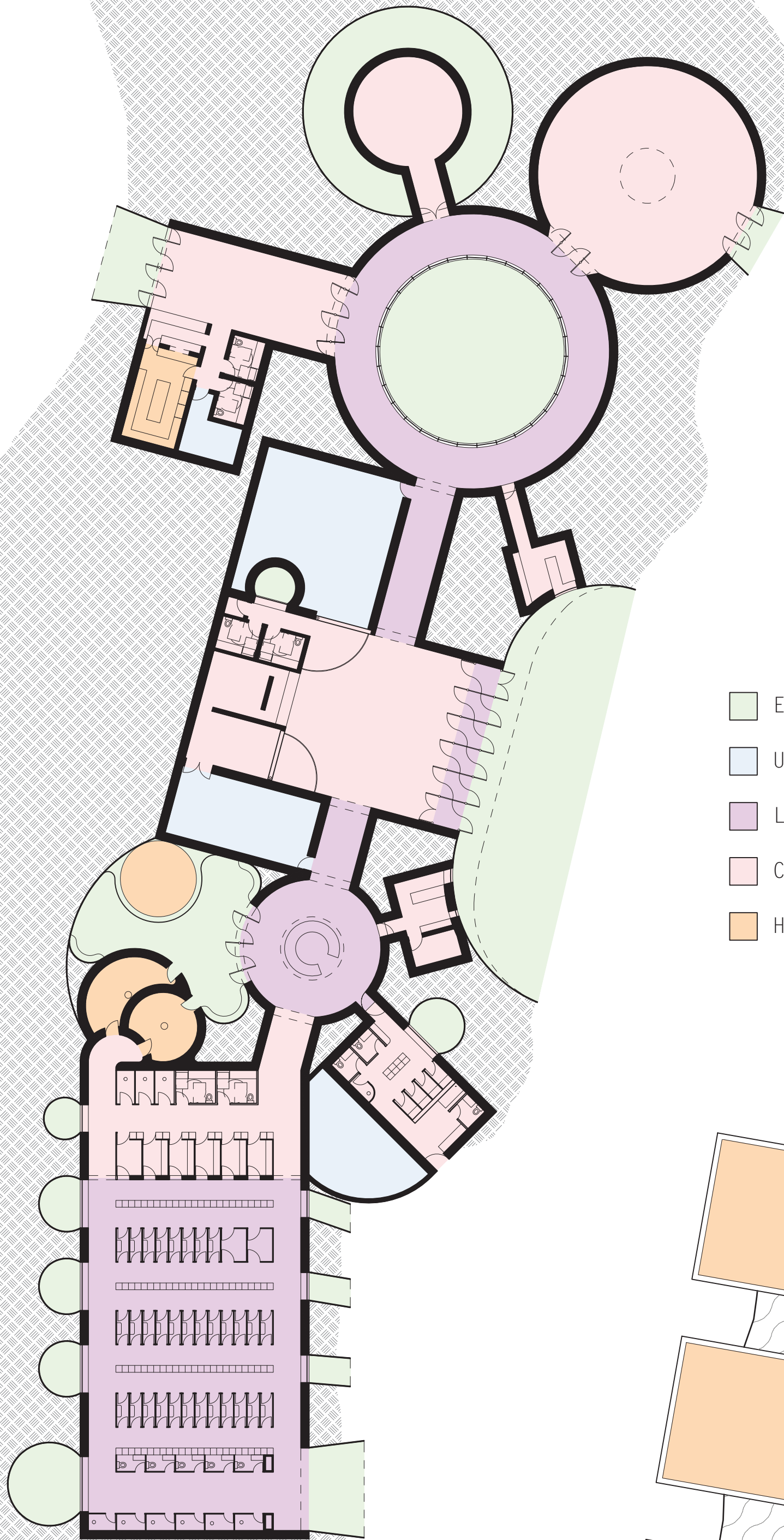



- EXTERIOR
- UNCONDITIONED
- LIGHTLY CONDITIONED
- CONDITIONED
- HEAVILY CONDITIONED

SCALE: 1/300
0 1 2 3 4 5 10m

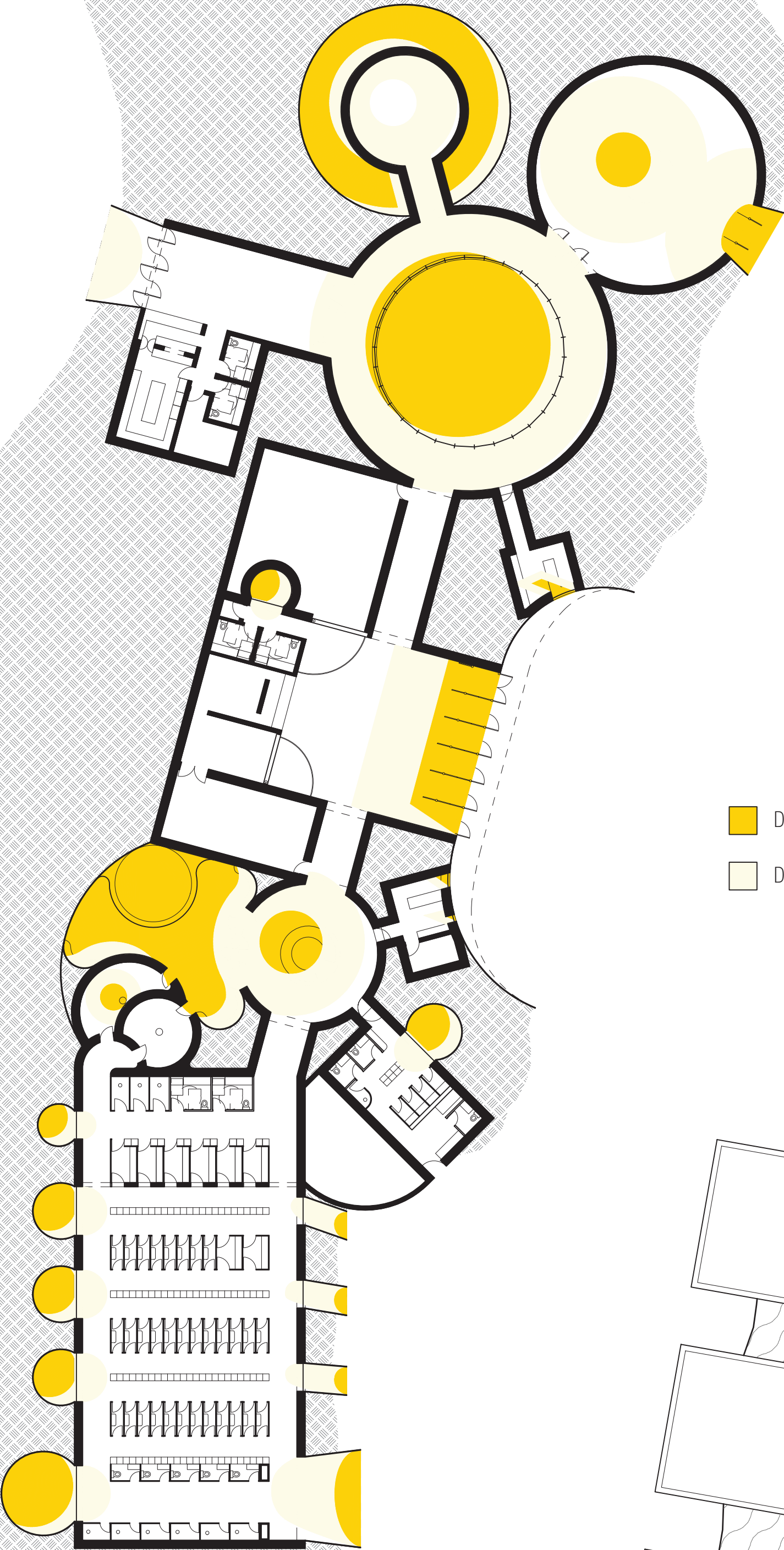
DAYLIGHTING



-  DIRECT SUNLIGHT
-  DIFUSE SUNLIGHT

One of the issues that arises with building underground is that bringing in daylight isn't as simple as opening a hole in a wall. Creating opportunity for daylight to enter the space becomes more dependent on the form of the building.

Daylighting the spaces not only reduces the energy consumption caused by relying solely on electric light, but also helps to counteract some of the negative associations that come with underground buildings. If users can always see daylight, even if it isn't directly in the space that they are occupying, it gives the space a vastly different feeling than if it relies solely on LEDs.

Because of the importance of daylighting on the comfort of users, this plan makes an effort to allow sunlight into all of the space in some way, or at a minimum to always have a view onto a sunlit space.

HALL COMFORT DIAGRAM

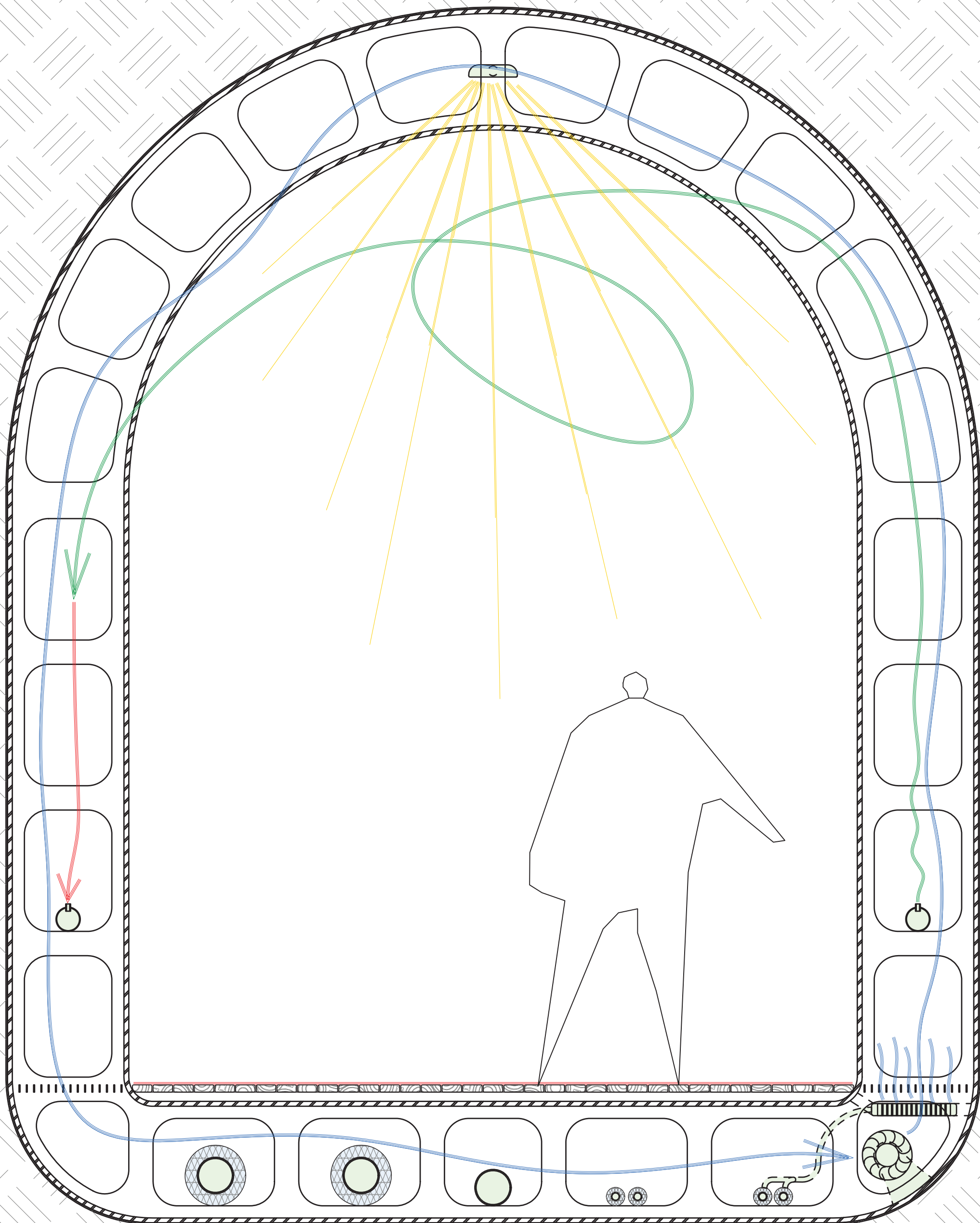

The hallways are one example of a space that doesn't immediately have a formally viable option to bring daylight into the space, so the immediate space does rely on LED lighting for visibility.

However, the hallways are on the axis that gives either end a view directly into a bright space, either the lobby, the pool entrance, or the garden.

The other big effects on comfort are air quality and temperature. These are gone over in further depth in the systems portion of the document, but the basic principle of all of the spaces are;

- Lots of local airflow to ensure users have the impression of air movement, to move heat or cool to usefull elevations, and to dry out the floor
- Connection to the central system to remove and replace stale air.
- Floor level radiators working in tandem with teh local fans to effectively moderate the temperature of the space when the envelope of the building is sealed.

EVENT SPACE COMFORT DIAGRAM

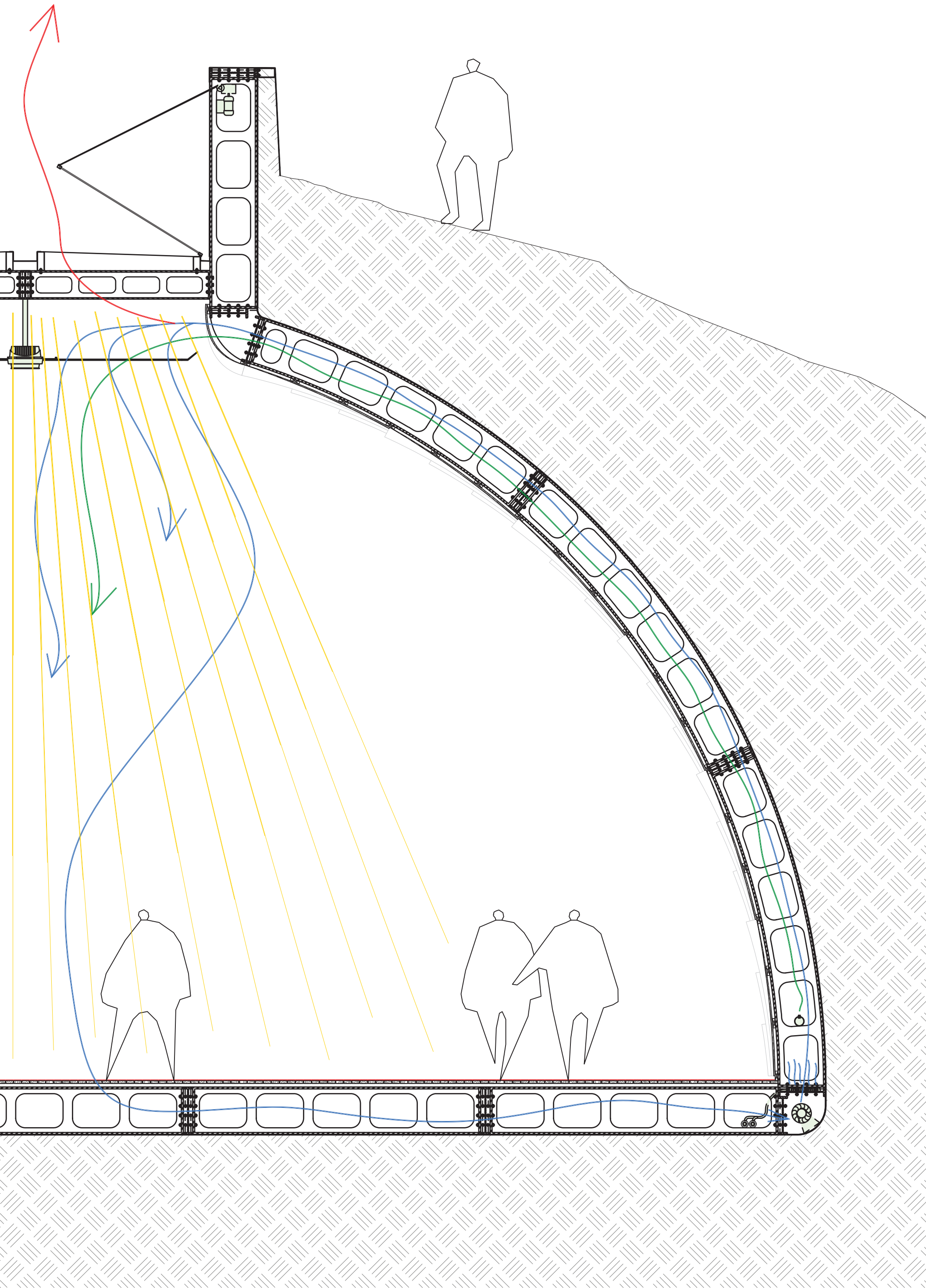

The event space is much larger than the hallway, but the core principles are the same.

The additional opportunity that comes with the event hall is the use of the 4m skylight in the centre of the space.

This skylight greatly enhances the environment of the space by allowing large amounts of daylight in, as well as giving direct ventilation to the exterior. When weather is permitting, the skylight can be opened to allow airflow to flow up and out with the stack effect. If there isn't enough wind or temperature differential to create a breeze, there is a large fan placed in the skylight to mechanically assist.

The interior of the event space is also covered in curved wooden strips. The twisting of the strips allows them to better fit the shape of the sphere, and also provides acoustic benefits by creating a baffling effect. Without this, the spherical form would be very liable to suffer from extensive noise and echoing, especially during large gatherings.

CHANGEROOM COMFORT DIAGRAM

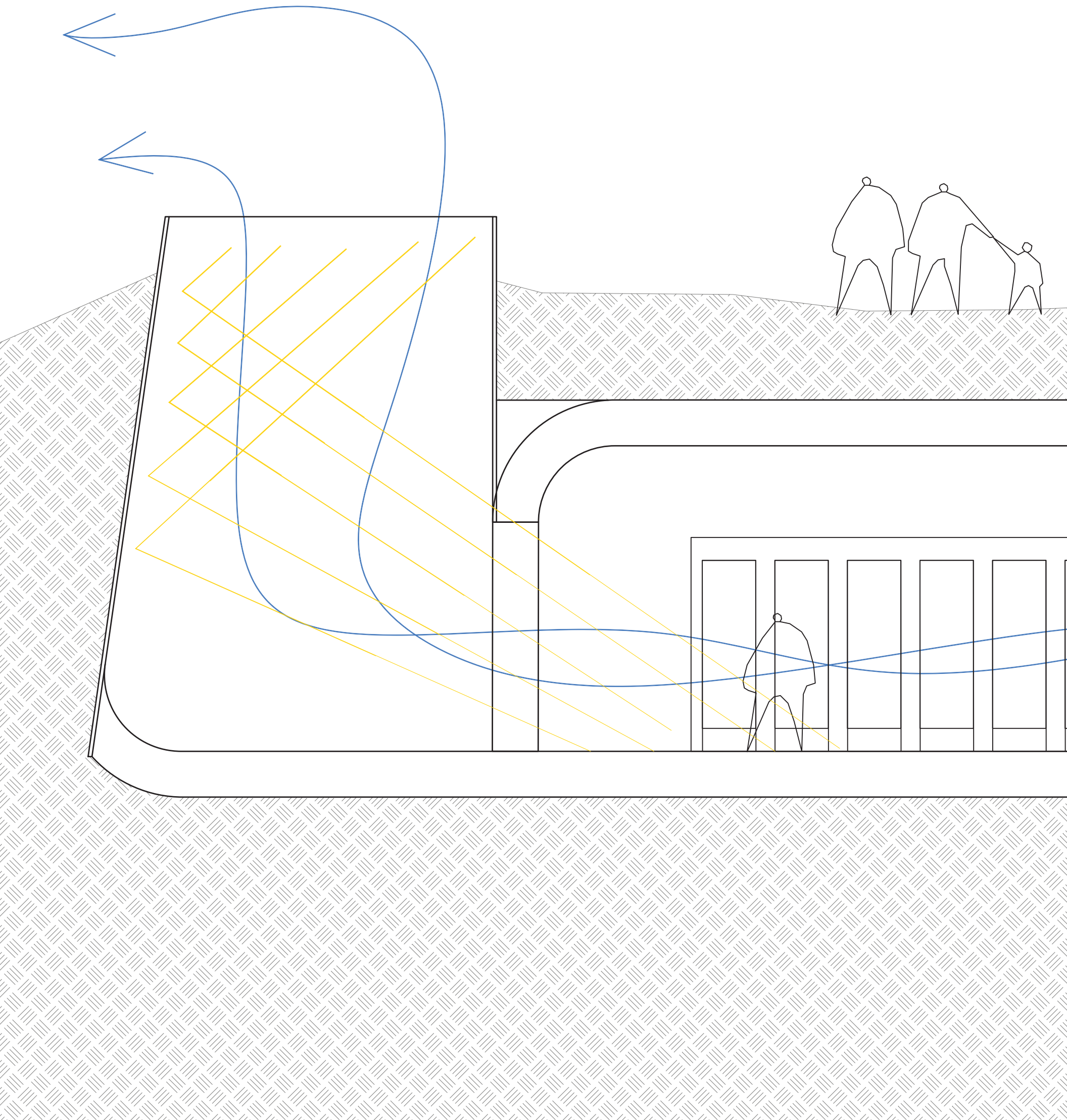

The seasonal portion of the changeroom also has an interesting condition, because it relies almost entirely on passive strategies for creating a comfortable environment.

Again, the space is daylight at either end to make it feel large and open. Here, these openings also create the opportunity for extensive cross ventilation. With the prevailing South-West winds, the front scoops bring air in and through the space, for it to eventually move up and out the vertical cylinders at the other end of the space.

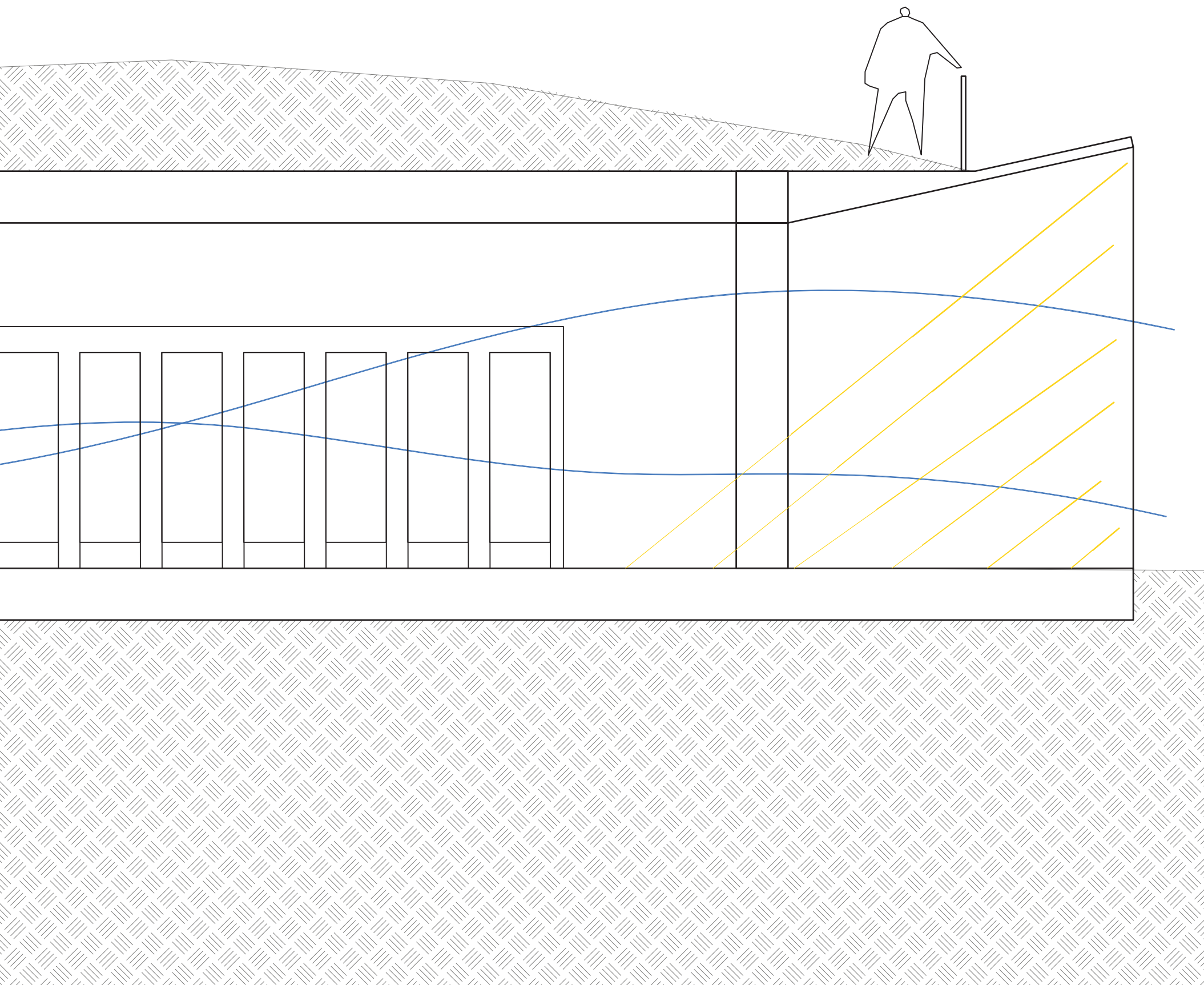

P2

TECHNICAL
REPORT

ARCH 493 / ARCH 473

JUNE 27TH, 2019

NATHANAEL SCHEFFLER

20561551

BUILDING
ENVELOPE

SECTION 1: HALLWAY

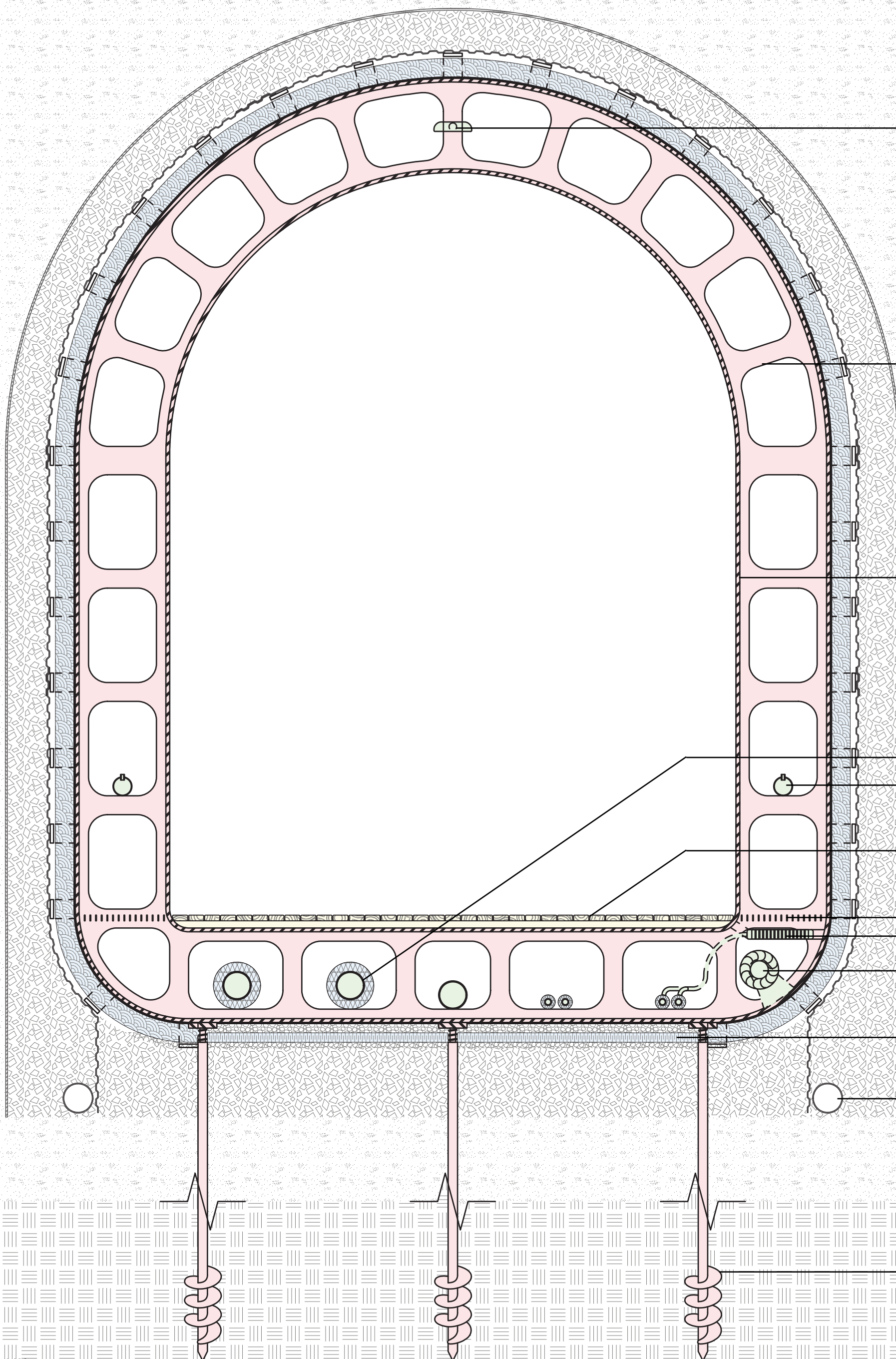

SCALE: 1/20
0 1 2 3 4 5m

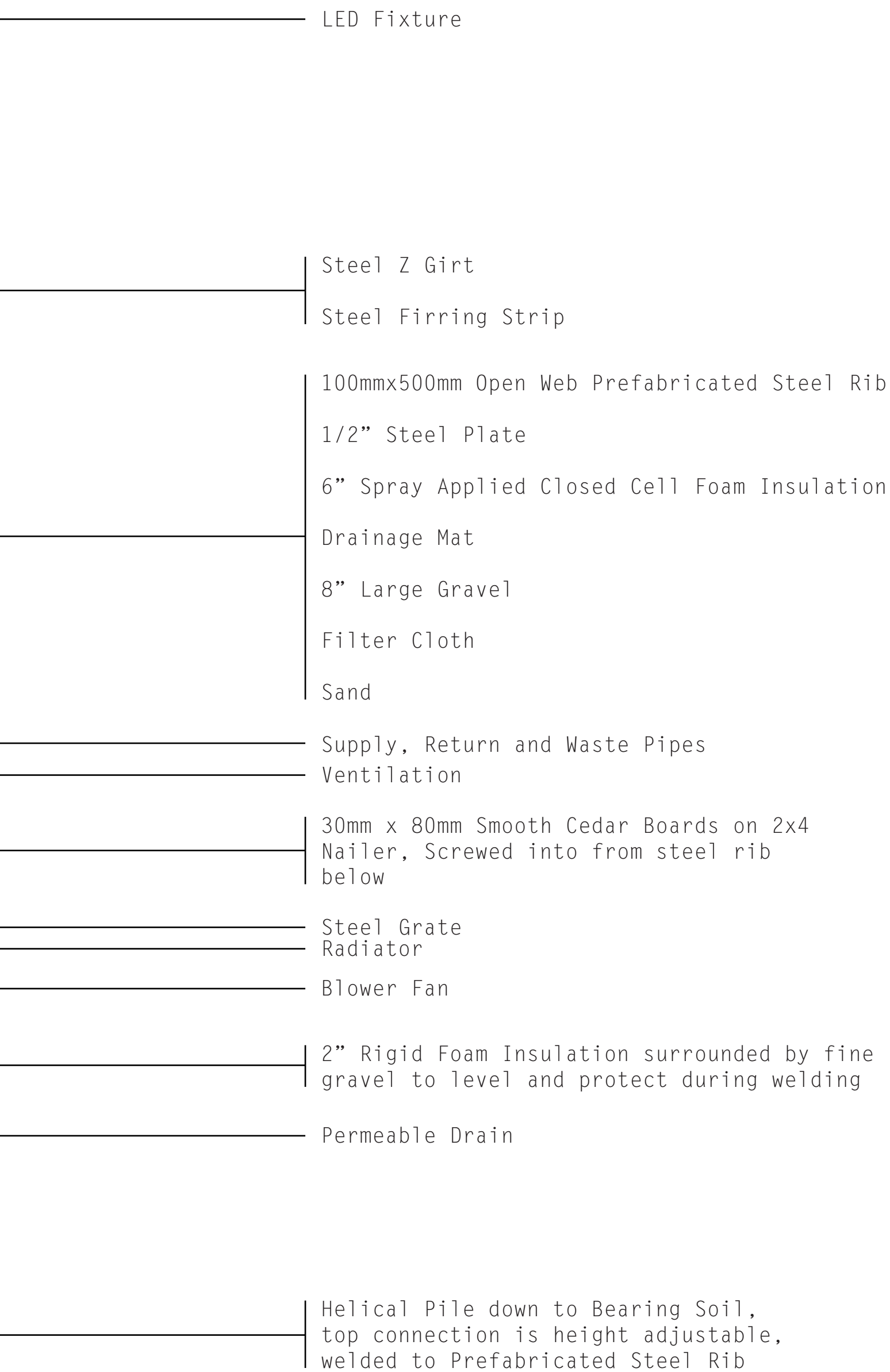

DETAIL 1: HALLWAY BASE

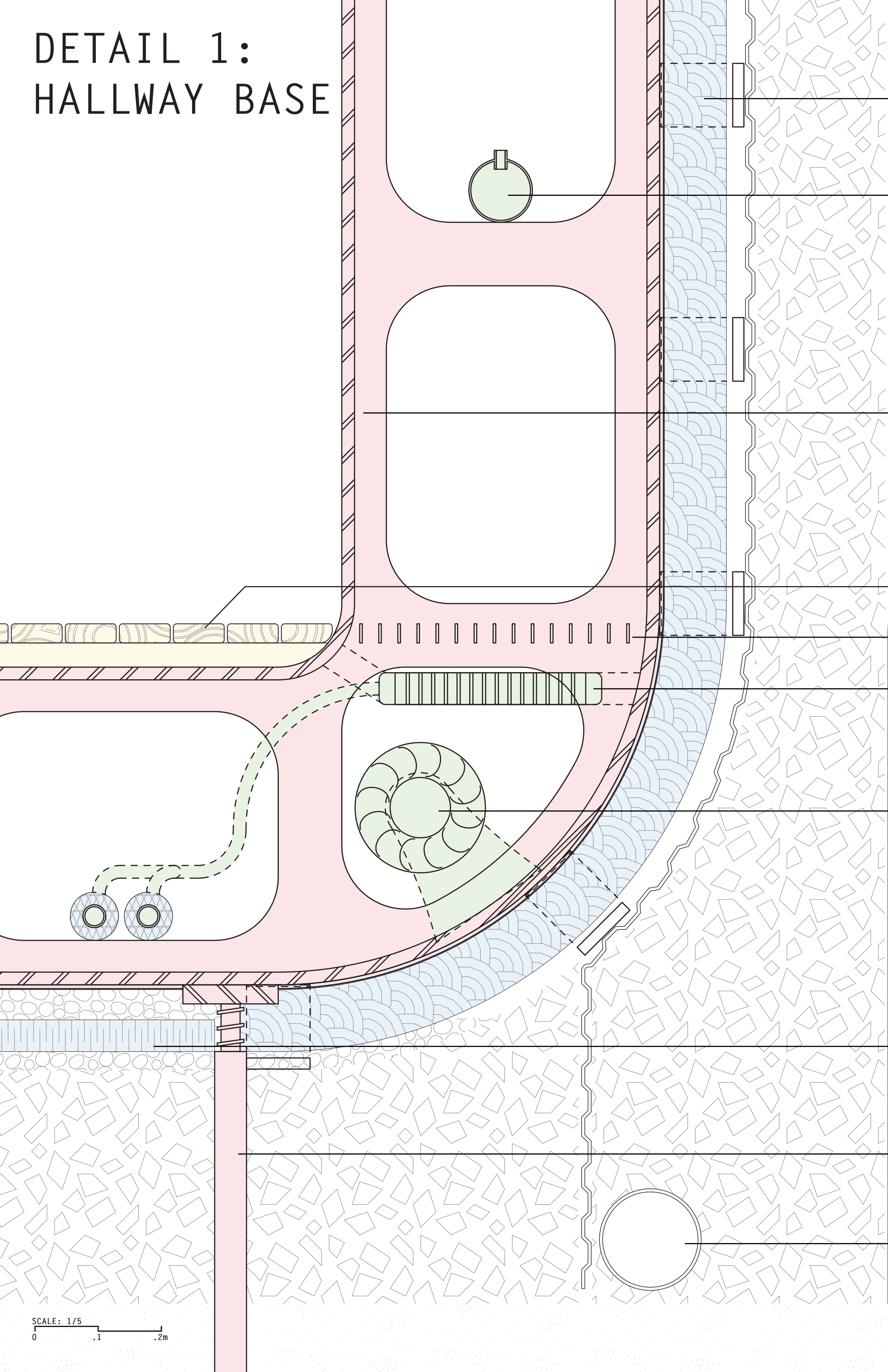

SCALE: 1/5
0 .1 .2m

Steel Z Girt

Steel Furring Strip

Ventilation

100mmx500mm Open Web Prefabricated Steel Rib

1/2" Steel Plate

6" Spray Applied Closed Cell Foam Insulation

Drainage Mat

8" Large Gravel

Filter Cloth

Sand

30mm x 80mm Smooth Cedar Boards on 2x4
Nailer, Screwed into from steel rib
below

Steel Grate

Radiator

Blower Fan

2" Rigid Foam Insulation surrounded by fine
gravel to level and protect during welding

Helical Pile down to Bearing Soil,
top connection is height adjustable,
welded to Prefabricated Steel Rib

Permeable Drain

SECTION 2: EVENT SPACE

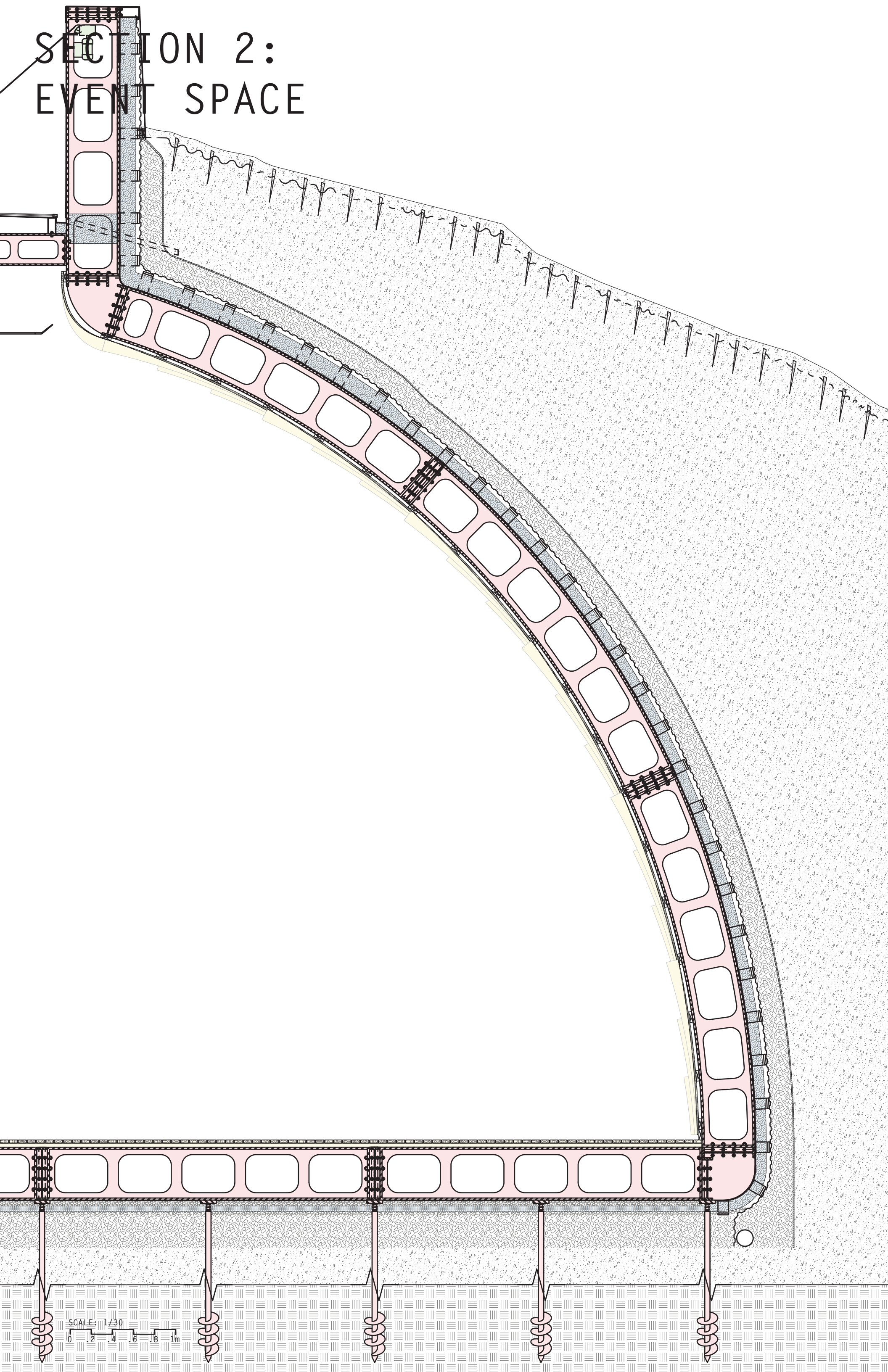

ABOVE GRADE WALL PLAN

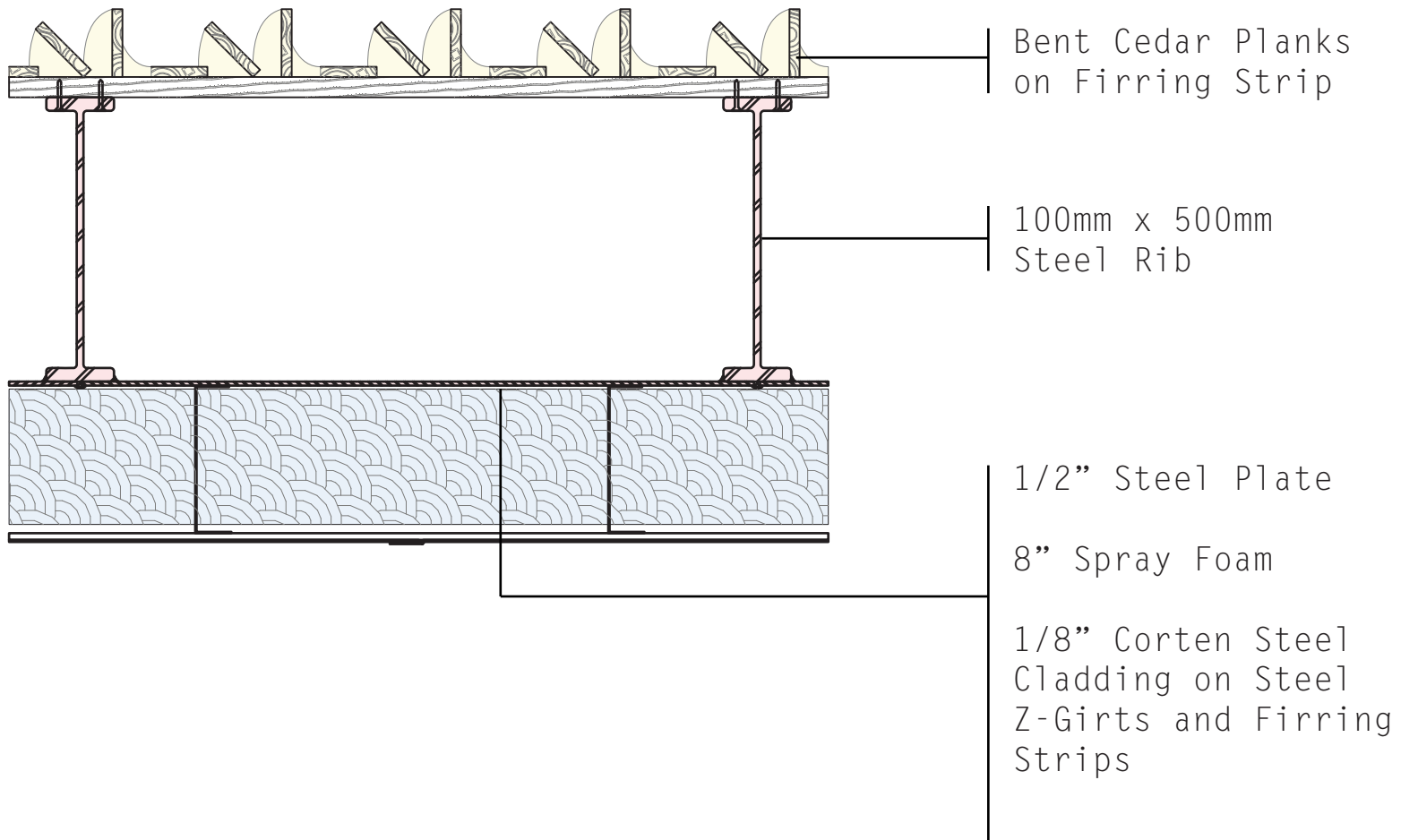

BELOW GRADE WALL PLAN

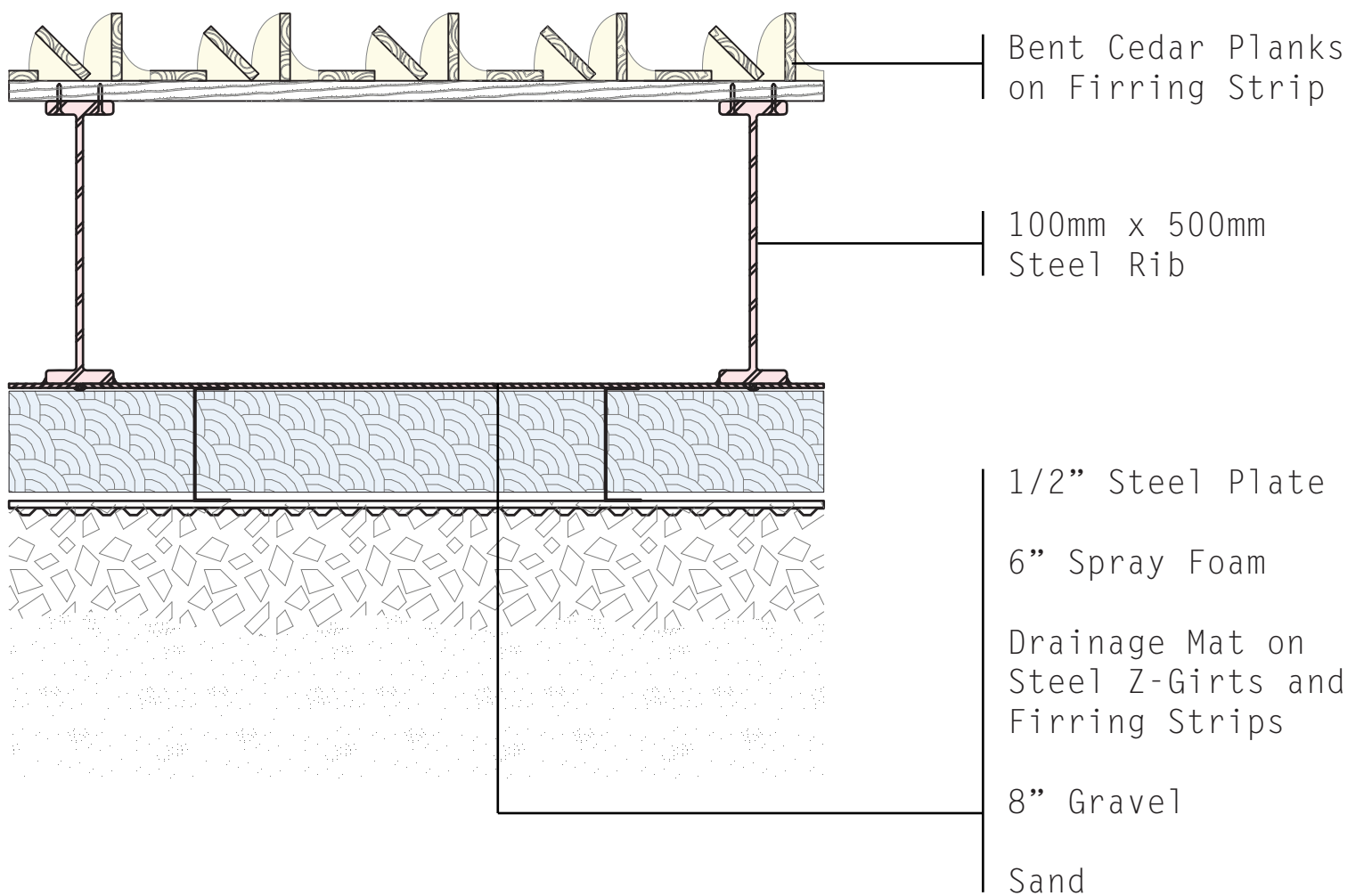

SECTION 2a: EVENT SPACE LOWER

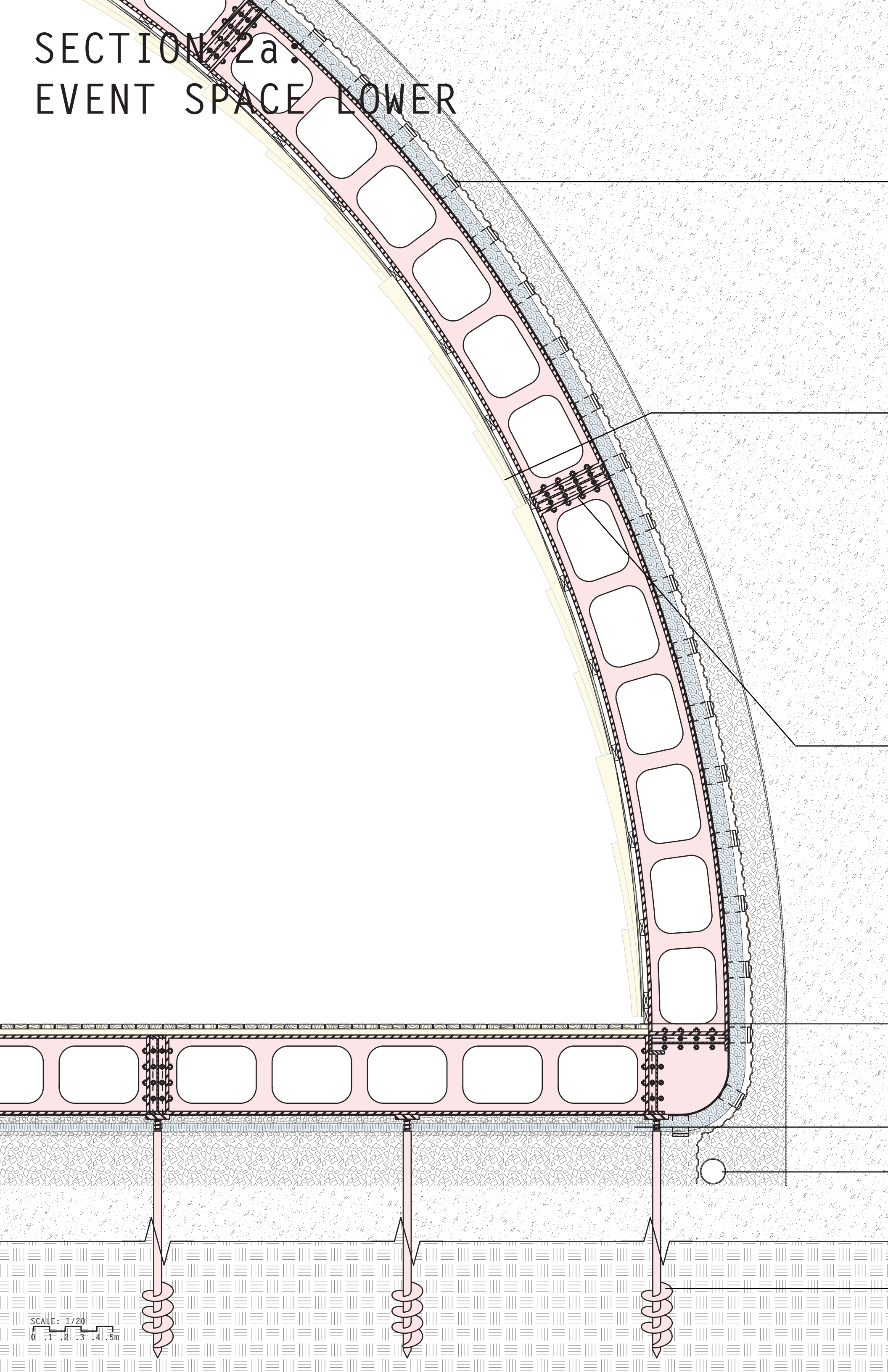

SCALE: 1/20
0 1 2 3 4 5m

Steel Z Girt

Steel Furring Strip

Bent Cedar Strips on Furring Strip

100mmx500mm Open Web Prefabricated Steel Rib

1/2" Steel Plate

6" Spray Applied Closed Cell Foam Insulation

Drainage Mat

8" Large Gravel

Filter Cloth

Sand

100mm x 100mm x 500mm Hollow Square
Structural Tube with welded on threads for
connecting ribs (see structural section)

30mm x 80mm Smooth Cedar Boards on 2x4
Nailer, Screwed into from steel rib
below

2" Rigid Foam Insulation surrounded by fine
gravel to level and protect during welding

Permeable Drain

Helical Pile down to Bearing Soil,
top connection is height adjustable,
welded to Prefabricated Steel Rib

DETAIL 2: EVENT SPACE BASE

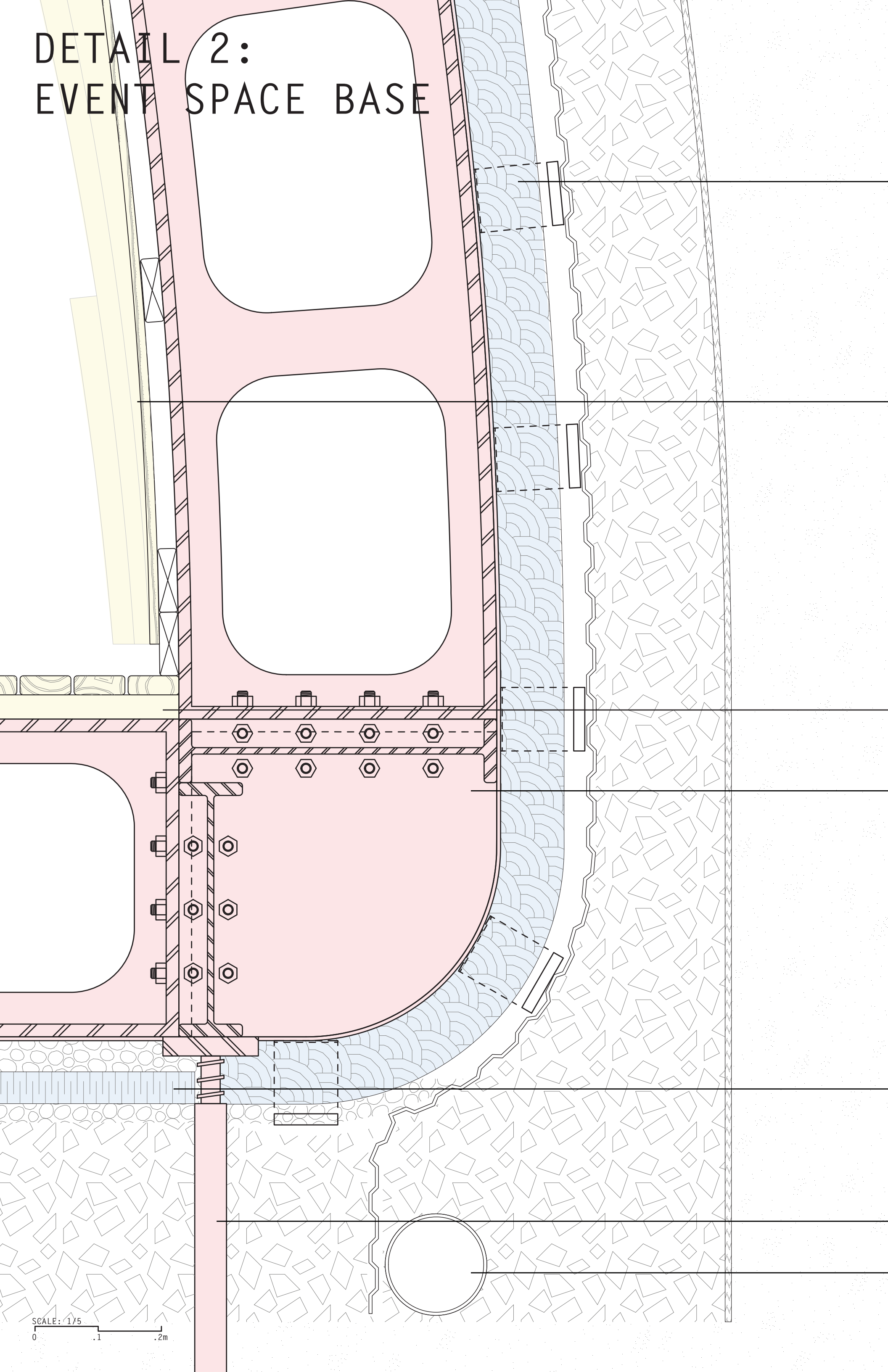

SCALE: 1/5
0 .1 .2m

Steel Z Girt

Steel Furring Strip

Bent Cedar Strips on Furring Strip

100mmx500mm Open Web Prefabricated Steel Rib

1/2" Steel Plate

6" Spray Applied Closed Cell Foam Insulation

Drainage Mat

8" Large Gravel

Filter Cloth

Sand

30mm x 80mm Smooth Cedar Boards on 2x4
Nailer, Screwed into from steel rib
below

500mm x 100mm x 500mm Built Up Box with
welded on threads for connecting ribs (see
structural section)

2" Rigid Foam Insulation surrounded by fine
gravel to level and protect during welding

Helical Pile down to Bearing Soil,
top connection is height adjustable,
welded to Prefabricated Steel Rib

Permeable Drain

SECTION 2b: EVENT SPACE UPPER

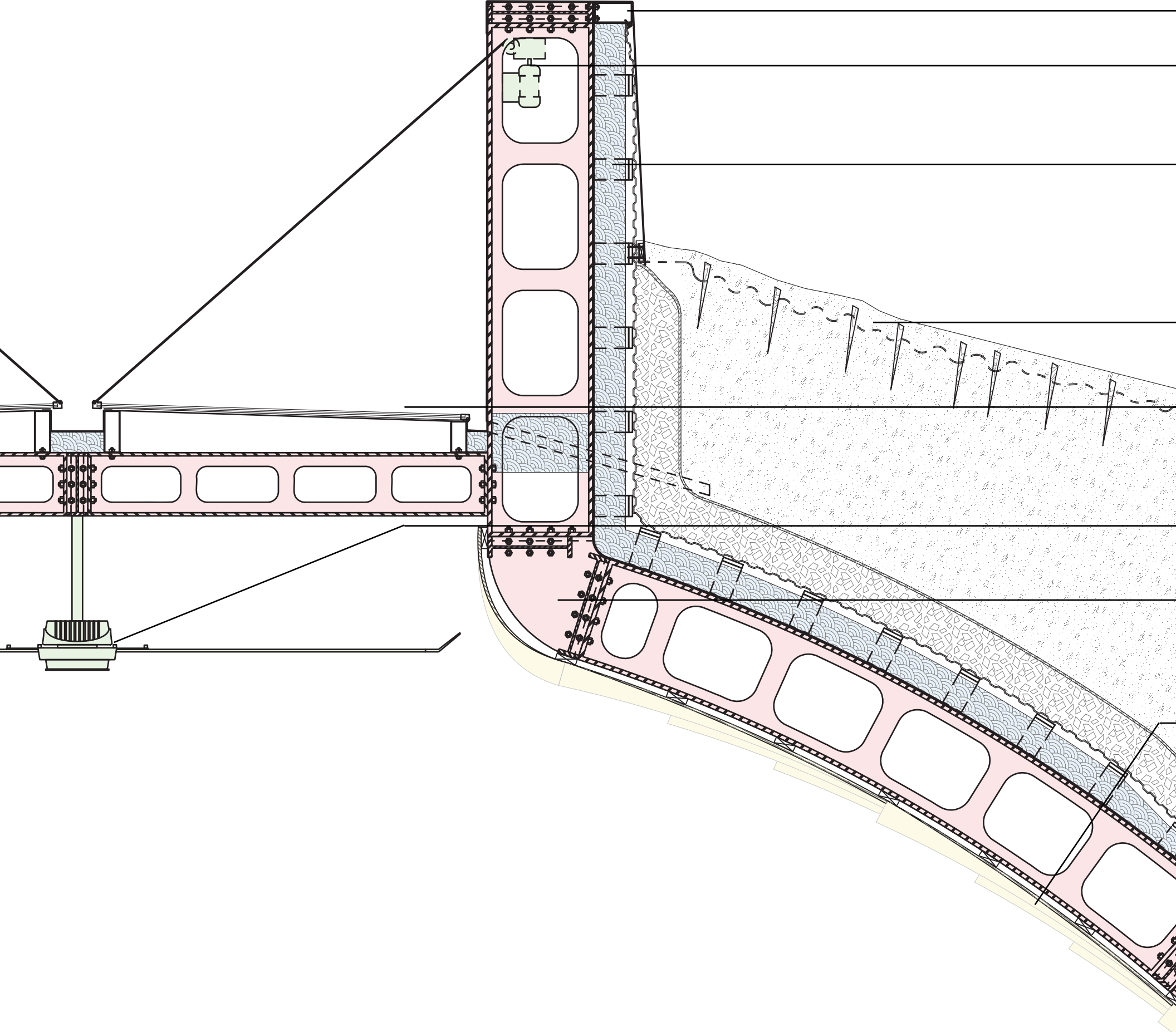

SCALE: 1/20
0 .1 .2 .3 .4 .5m

	Steel Box supported by blind hole crush bolts
	Skylight Cable Hoist
	Steel Z Girt
	Steel Furring Strip
	Geotextile held in place with Wooden Stakes until planting takes root and the root mat holds the sand in place
	Operable Skylight
	4m Diameter Ceiling Fan
	500mm x 100mm x 500mm Hollow Square Structural Tube with welded on threads for connecting ribs (see structural section)
	Bent Cedar Strips on Furring Strip
	100mmx500mm Open Web Prefabricated Steel Rib
	1/2" Steel Plate
	6" Spray Applied Closed Cell Foam Insulation
	Drainage Mat
	8" Large Gravel
	Filter Cloth
	Sand

DETAIL 3: EVENT SPACE UPPER

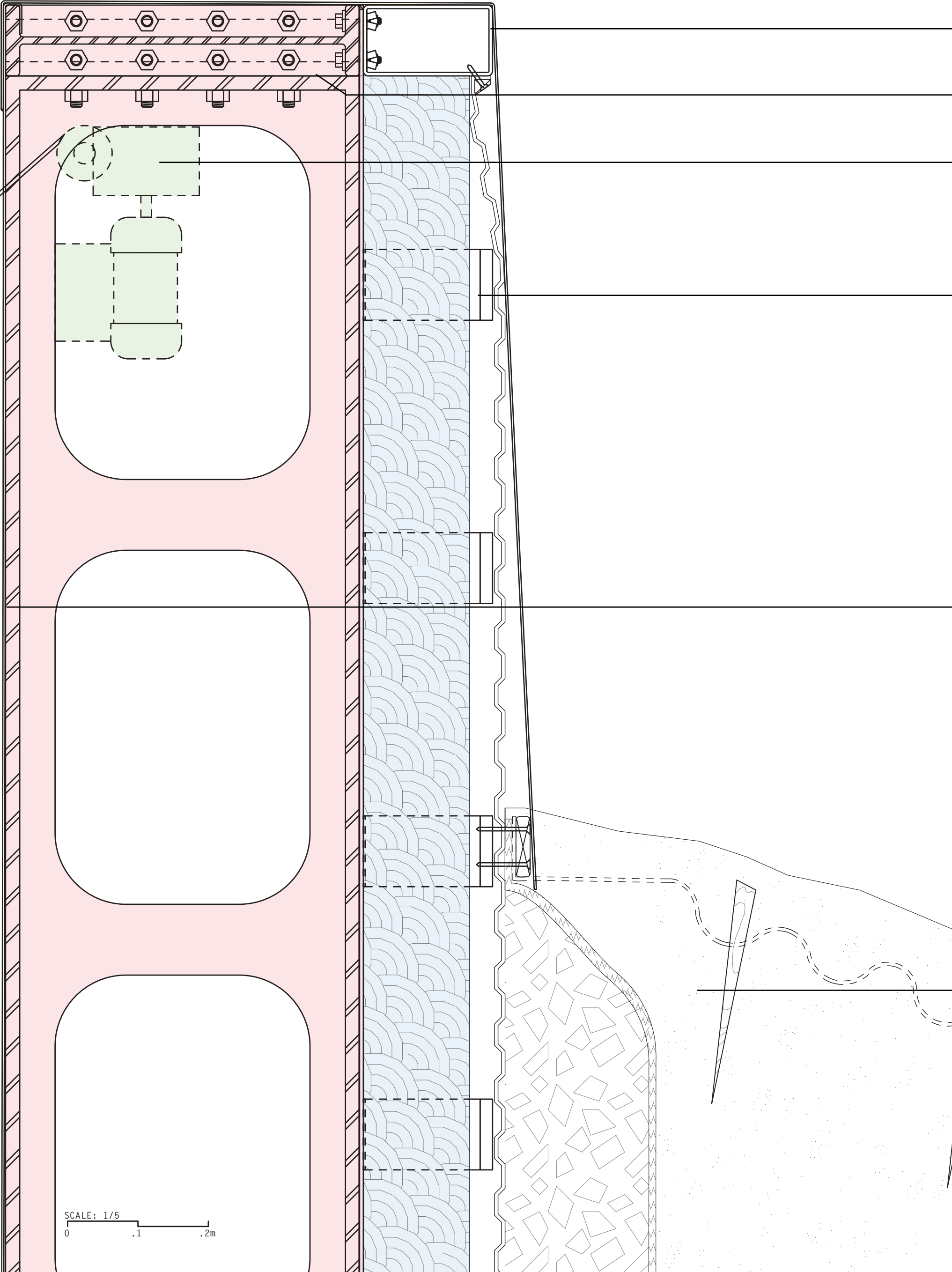

SCALE: 1/5
0 .1 .2m

Steel Box supported by blind hole crush bolts

100mm x 100mm x 500mm Hollow Square
Structural Tube with welded on threads for
connecting ribs (see structural section)

Skylight Cable Hoist

Steel Z Girt

Steel Furring Strip

1/8" Corten Steel Panel

100mmx500mm Open Web Prefabricated Steel Rib

1/2" Steel Plate

8" Spray Applied Closed Cell Foam Insulation

Drainage Mat

1/8" Corten Steel Panel

Geotextile held in place with Wooden Stakes
until planting takes root and the root mat
holds the sand in place

P2

TECHNICAL
REPORT

ARCH 493 / ARCH 473

JUNE 27TH, 2019

NATHANAEL SCHEFFLER

20561551

SYSTEMS

ENVIRONMENTAL ZONES

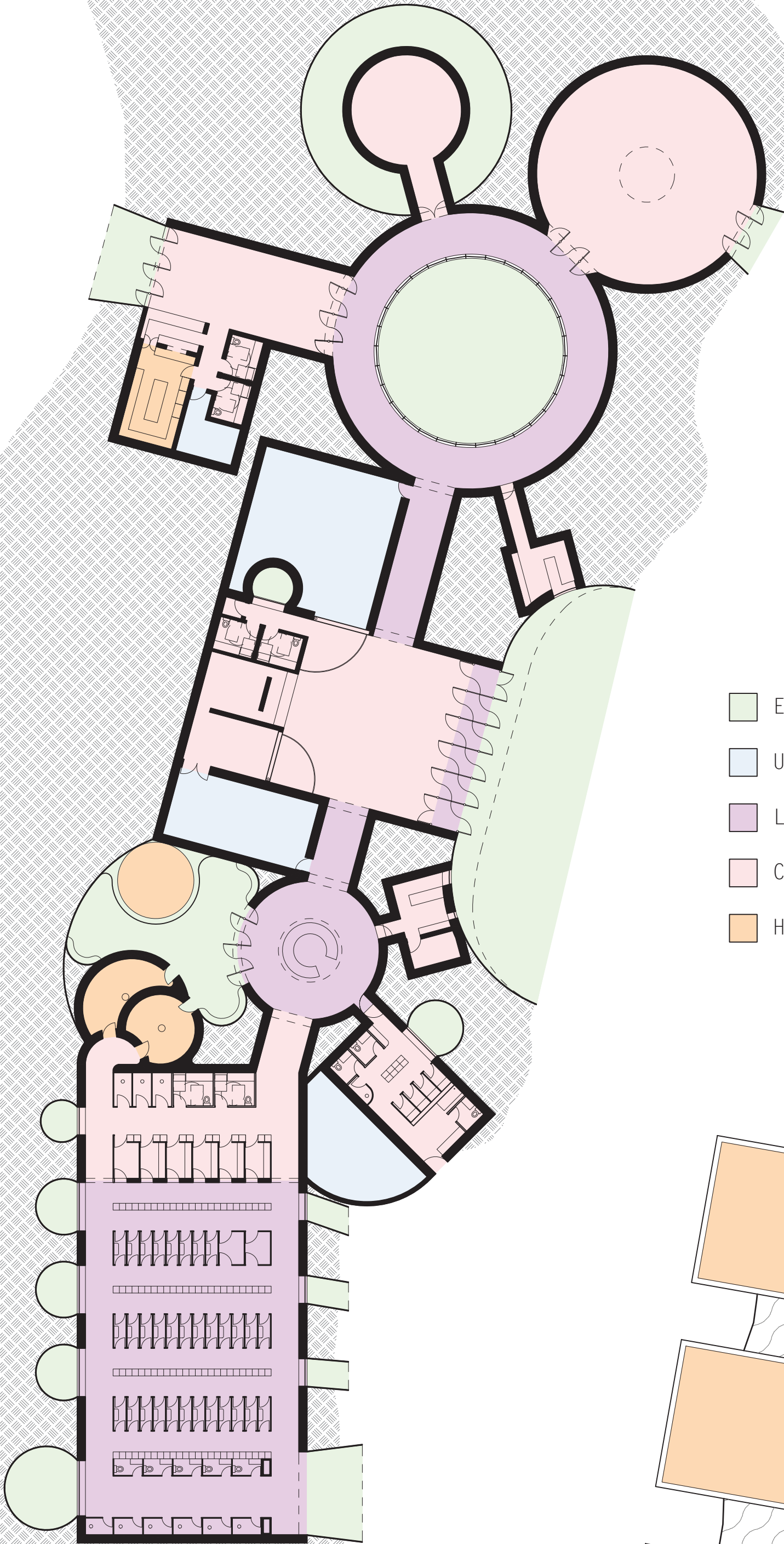

- EXTERIOR
- UNCONDITIONED
- LIGHTLY CONDITIONED
- CONDITIONED
- HEAVILY CONDITIONED

SCALE: 1/300
0 1 2 3 4 5 10m

The various areas and programs of the building are depicted with their required levels of climate control. Some areas of the program, like the pools, saunas and hot tub, require extensive amounts of energy to keep them at optimal condition. On the other side, there are parts of the program that require basically no conditioning, such as storage rooms.

By controlling which parts of the program receive support from the various building systems, we can make the system as efficient as possible by eliminating unnecessary loads.

VENTILATION

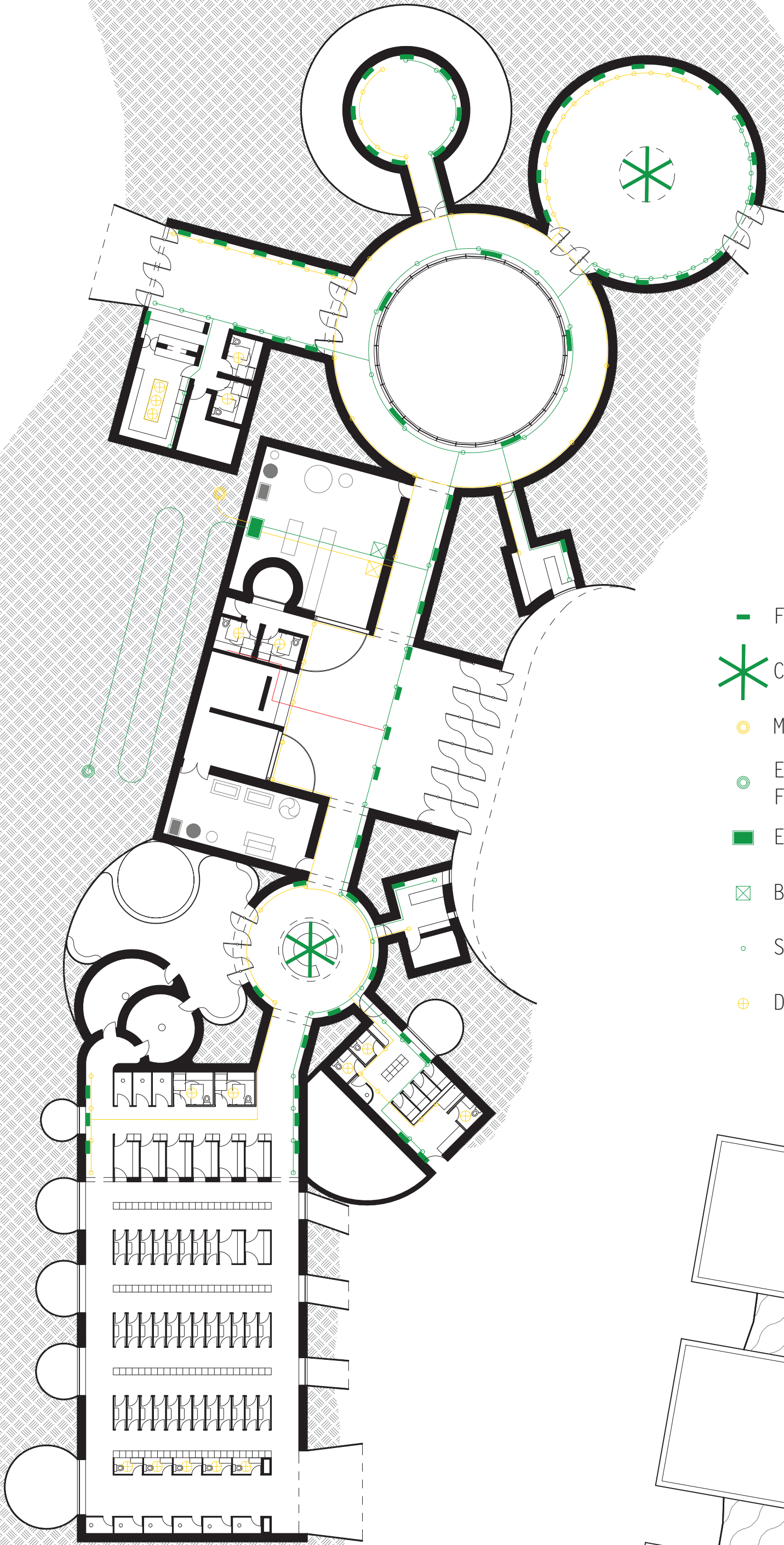

- FLOOR BLOWER FAN
- ✱ CEILING FAN
- MAIN EXHAUST
- EXTENDED INTAKE FOR TEMPERING AIR
- ENTHALPY RECOVERY
- ⊠ BOOSTER FAN
- SUPPLY OR RETURN
- ⊕ DIRECT EXHAUST

SCALE: 1/300
 0 1 2 3 4 5 10m

The ventilation of the building is extremely important, as this building is well sealed and the air will become stale if it isn't circulated.

The ventilation system uses a central circulation, as well as local circulation. The central circulation is responsible for the mechanical air changes, while the local circulation is responsible for mixing air for better temperature and for assisting with natural ventilation when the windows are open.

The intake of the building travels through a long pipe that is buried in the sand dune, helping to temper the air. Then it passes through an ERV to recover some of the heat and humidity of the exhaust air.





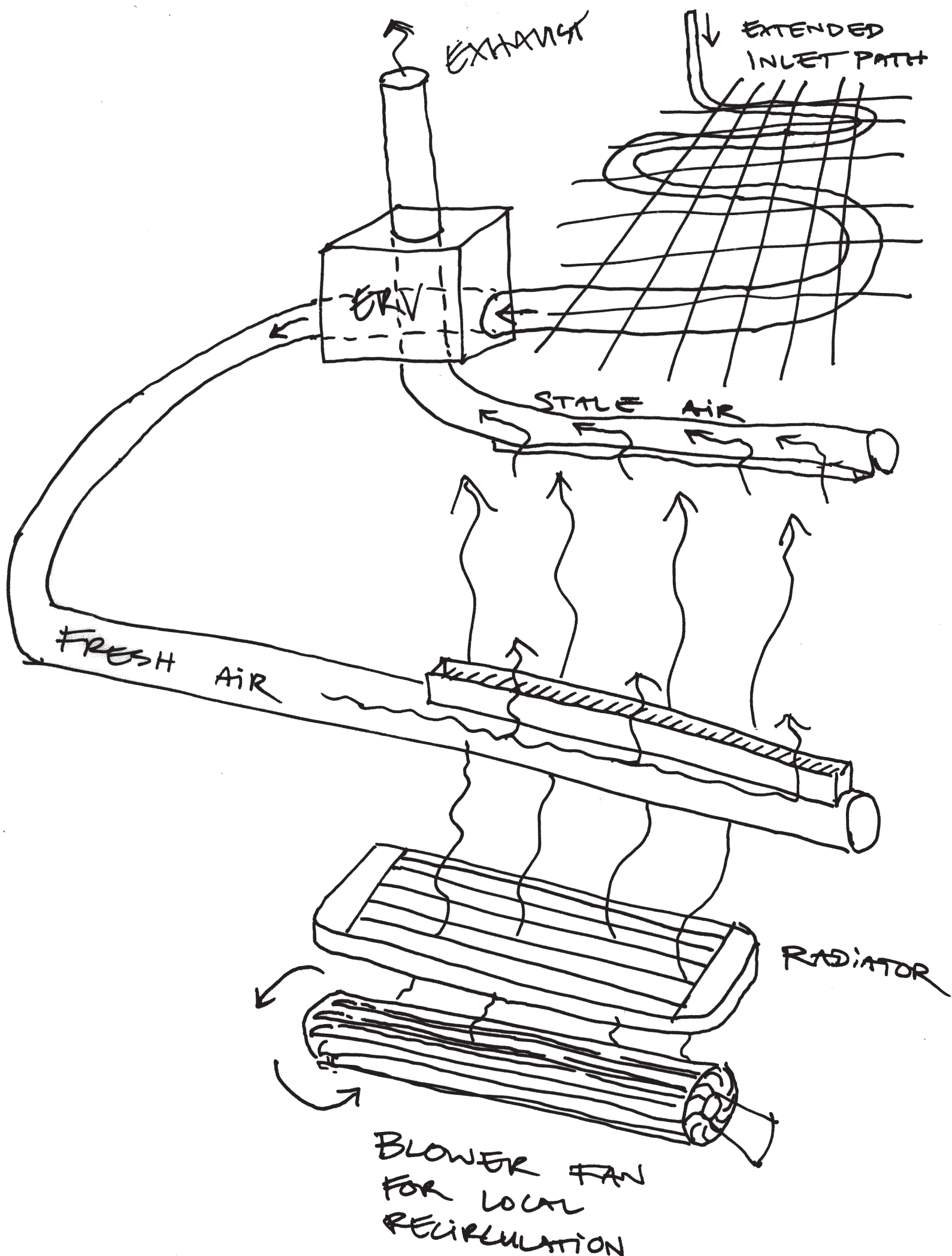

It is then delivered through small pipes to various vents throughout the building, areas that require more ventilation and air changes have more vents.

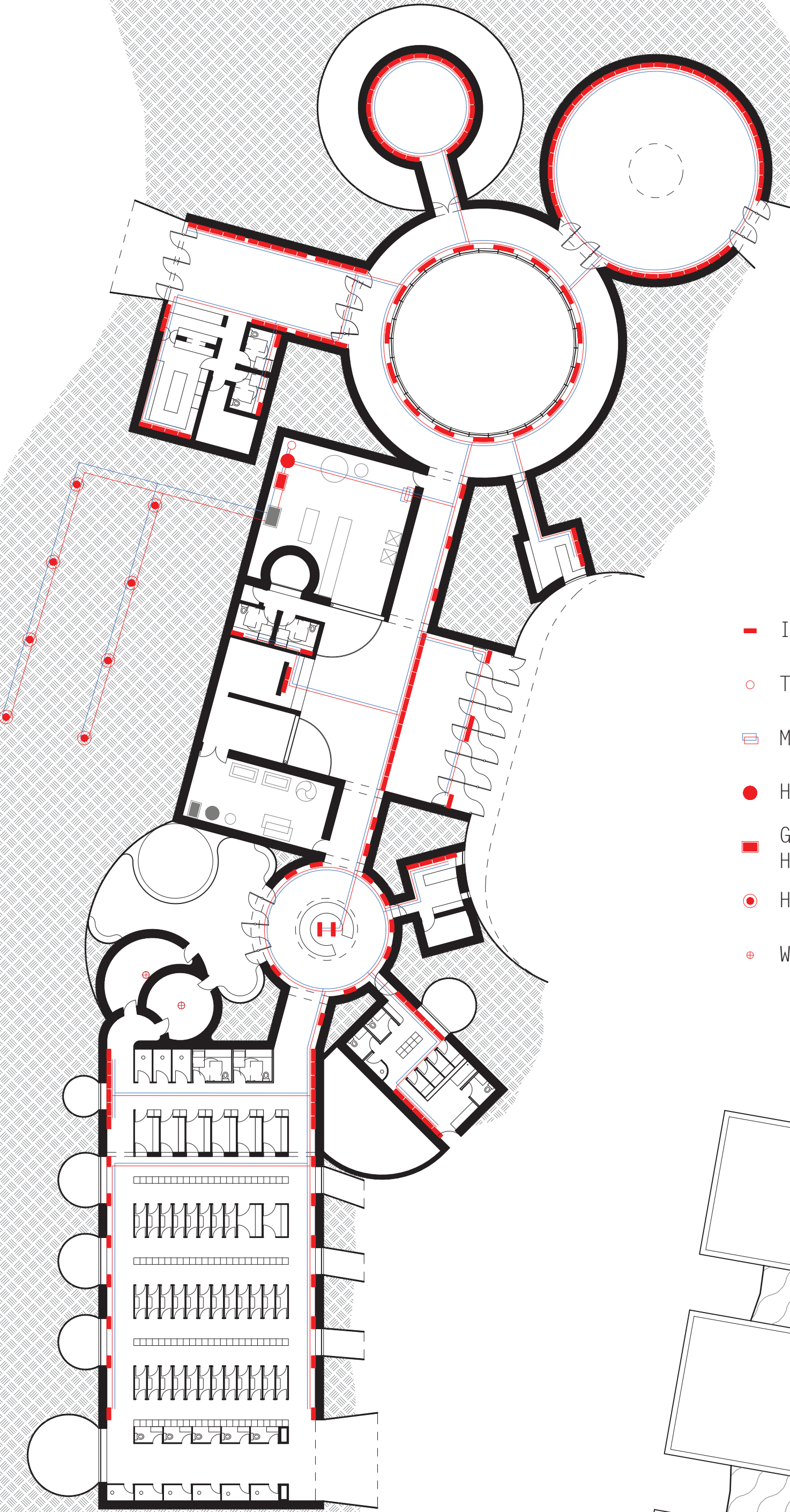
THE SAUNAS RELY ON THE OPENING OF THEIR DOORS FOR VENTILATION TO THE EXTERIOR. THE RESIDENCE IS SELF CONTAINED.



THERMAL SYSTEM



-  IN FLOOR RADIATOR
-  TOP UP BOILER
-  MANIFOLD
-  HEAT STORAGE TANK
-  GROUND SOURCE HEAT PUMP
-  HEAT PUMP BORE
-  WOOD STOVE

SCALE: 1/300
0 1 2 3 4 5 10m

The thermal system is centralized, and takes advantage of a ground source heat pump for high efficiency. The heat pump feeds to a bore field under the shallow part of the dune, so that the bores can be dug out if needing service.

The heat pump either heats or cools the glycol/water mix in the thermal loop, which services the array of radiators throughout the building. A top up boiler brings up the temperature during spikes.

The radiators are located at the floor level in between the spaces of the ribs. They take advantage of the localized ventilation to spread their heat more effectively.



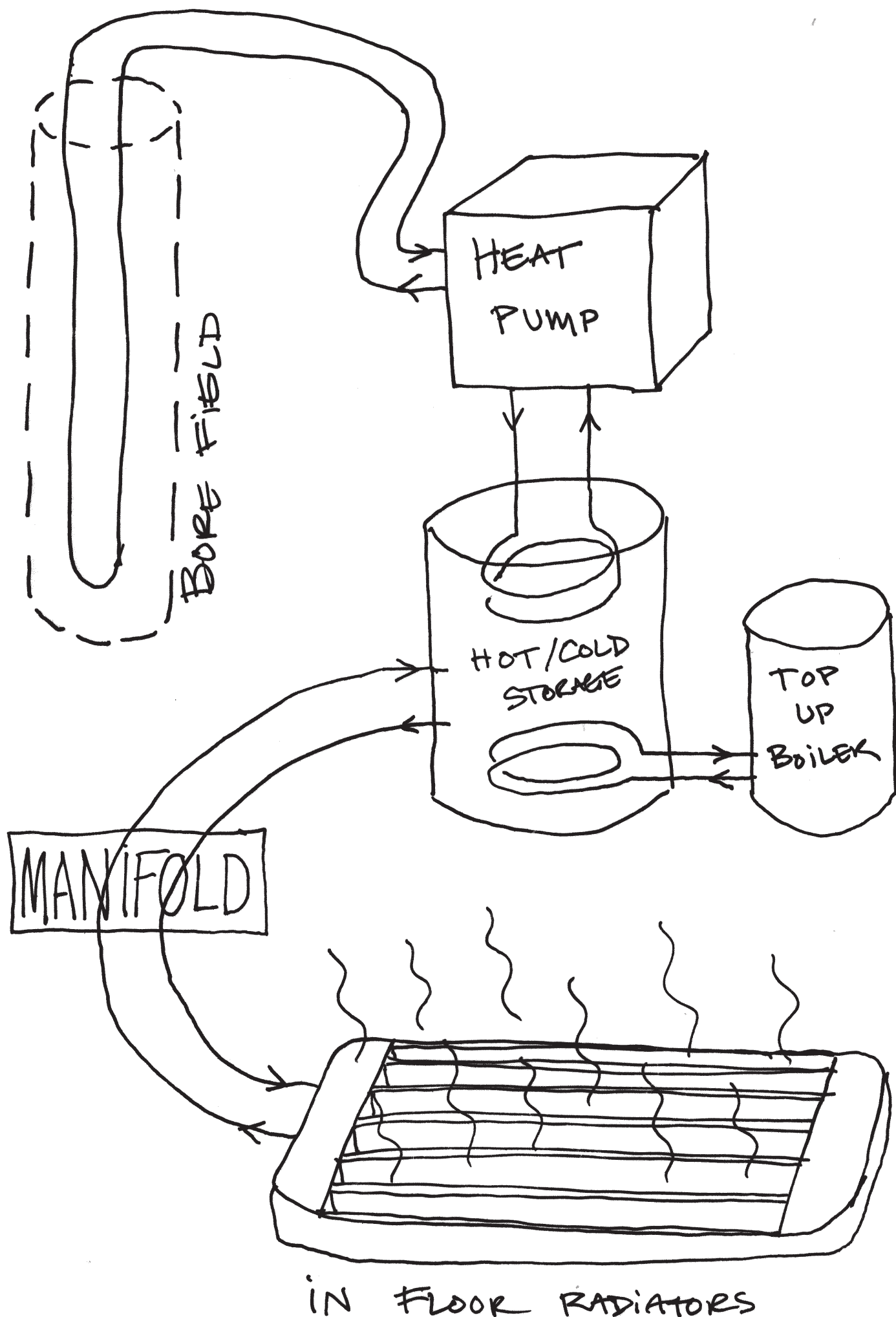

Because of their relatively small mass, they are quicker to respond to system changes than a radiant slab or wall.

THE SAUNAS ARE SERVICED BY SEPERATE WOOD FIRED UNITS THAT ARE SELF CONTAINED. THE RESIDENCE IS ALSO SELF CONTAINED.

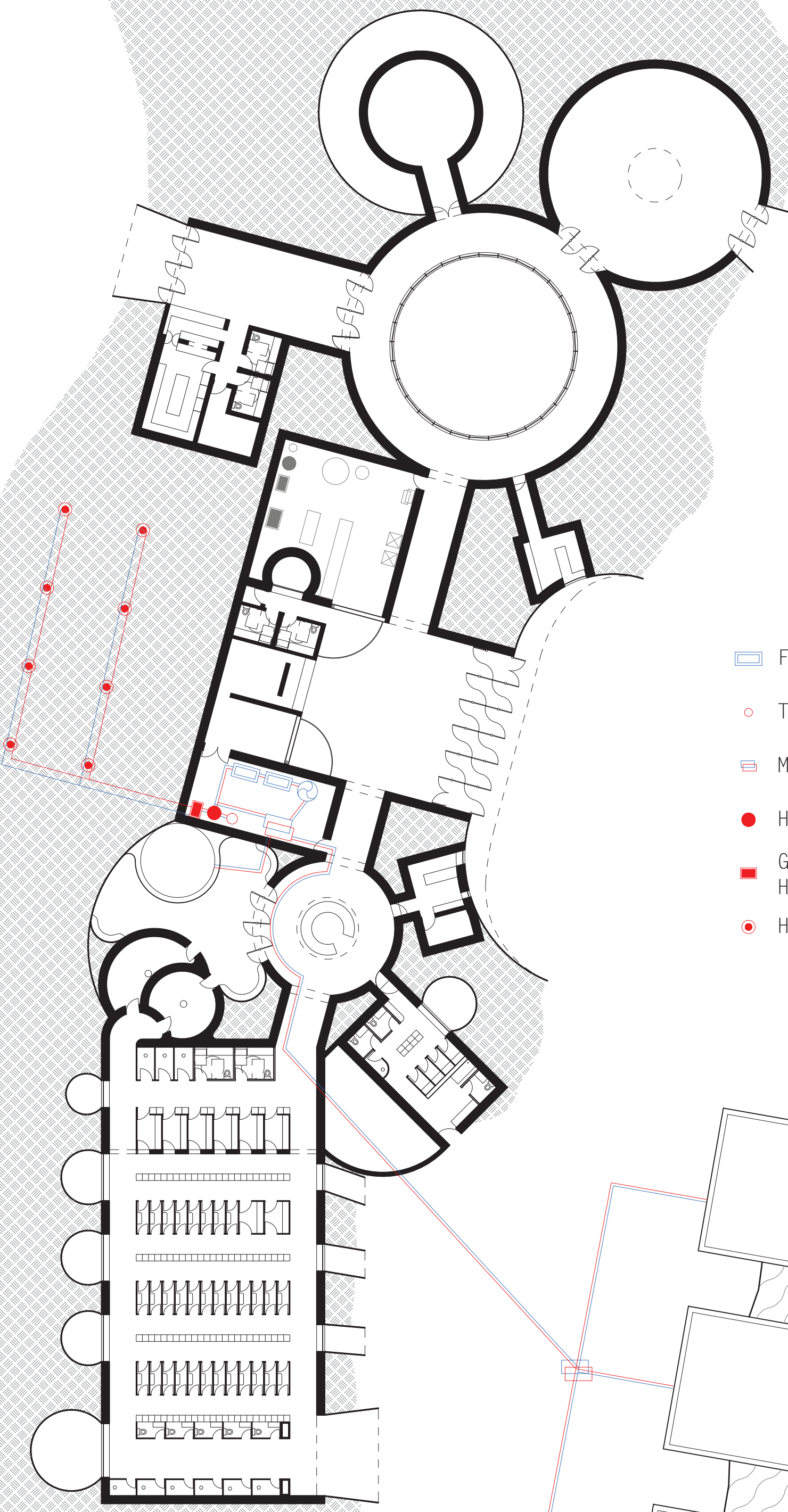

POOL SYSTEM



-  FILTER UNIT
-  TOP UP BOILER
-  MANIFOLD
-  HEAT STORAGE TANK
-  GROUND SOURCE HEAT PUMP
-  HEAT PUMP BORE

The pools also use a heat pump to achieve good efficiency. The extra step that the pools have that the thermal system doesn't is the requirement to go through a filtration and salination to treat the water.

The hot tub has a separate system after the heat pump manifold because of its different temperature requirement.

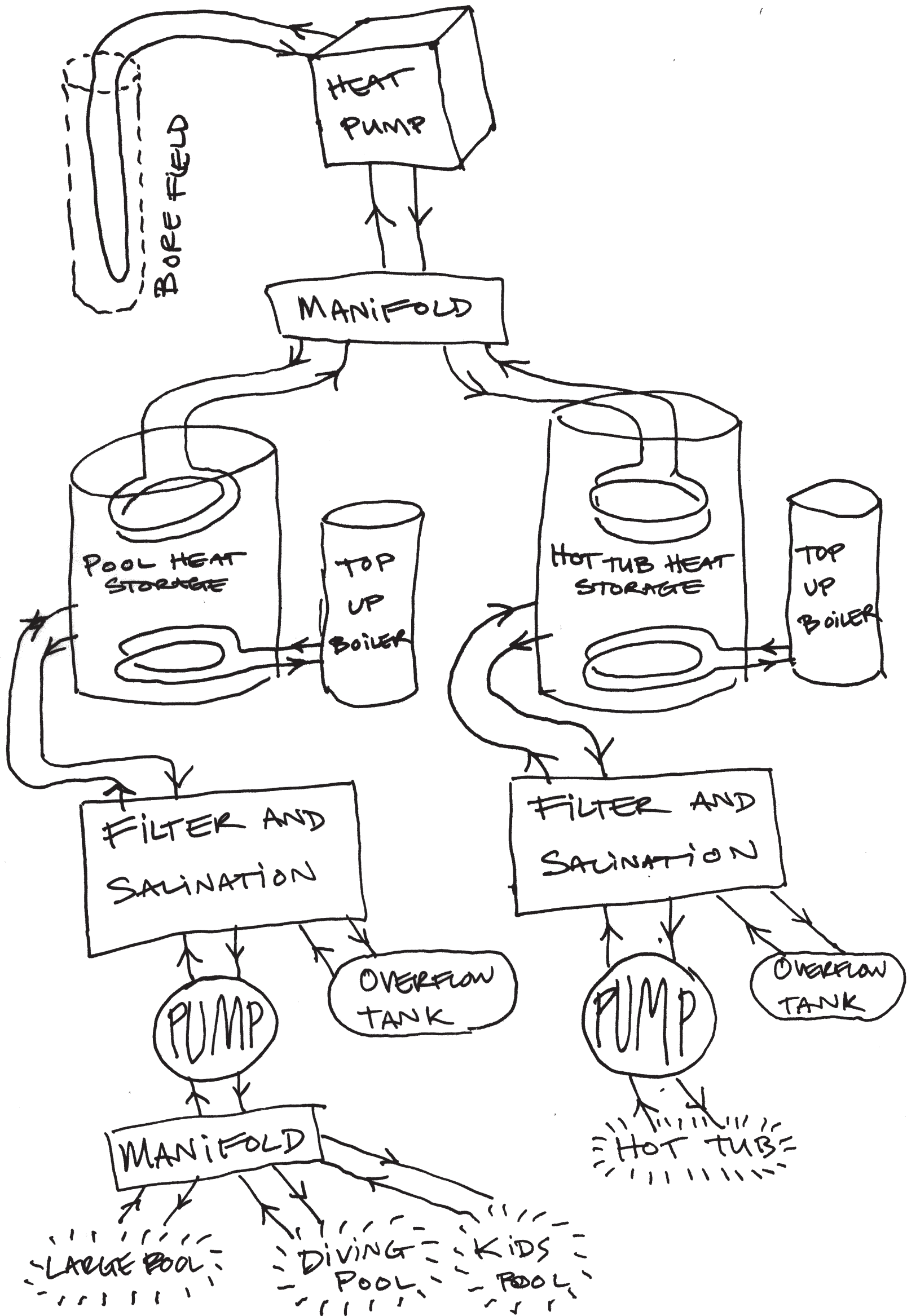

P2

TECHNICAL
REPORT

ARCH 493 / ARCH 473

JUNE 27TH, 2019

NATHANAEL SCHEFFLER

20561551

STRUCTURE

FOUNDATION PLAN

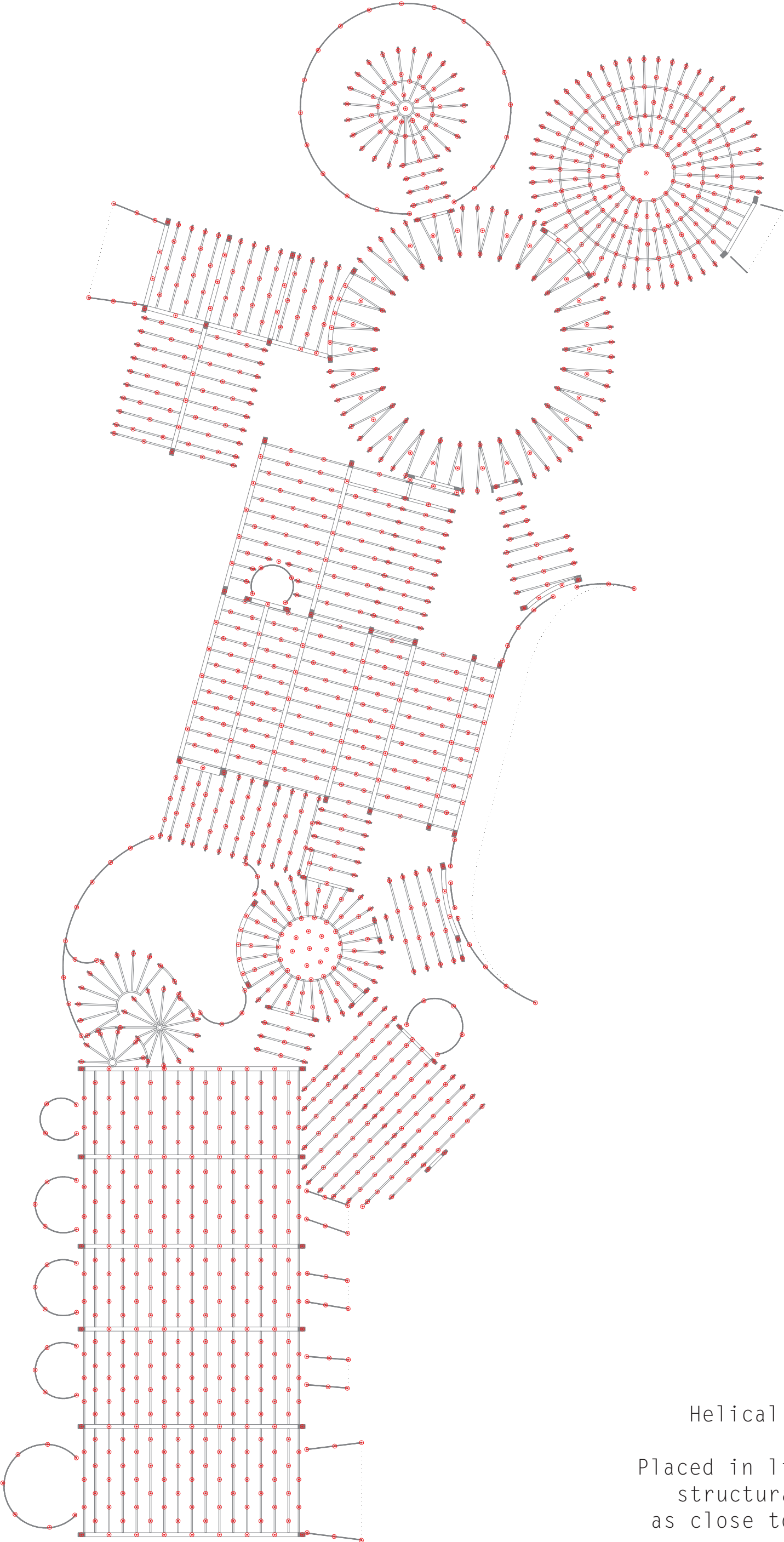

Helical Screw Piles

Placed in line with the structural ribs, and as close to 2m spacing as possible

The construction of the whole building would start with the foundation. After the base of the site is brought up to the required level for the building's floor to sit at, the field of helical piles would be anchored into the ground.

After the piles are in place, gravel would be spread and leveled, and then the floor insulation would be placed on top of that. Another layer of gravel would go on to protect the insulation from the upcoming welding.

The ribs and members would then be welded to their matching helical piles. The helical piles have a height adjust detail (see enclosure, sections) that would be brought level to ensure that all of the steel welded on is also perfectly level.

Once all of the ribs are in place, the outer shell of 1/2" steel would be welded between the members, and to the members at the joints. This would form a near continuous skin over the structure, like the hull of a boat or a submarine. This continuity would allow stresses to be better spread throughout the structure, and for it to very effectively resist lateral loads. Being buried in the sand dune would also help with lateral forces because the sand pressure will be relatively consistent on either side of the structure.

After the continuous skin is ready the z-girts would be spot welded on. Then the spray foam would be applied around them, and the furring strips over the foam. Then the corten steel panels or the drainage mat can be attached to the furring strips and the building can be sequentially buried to ensure proper layering of the gravel, filter cloth and sand.

STRUCTURAL PLAN

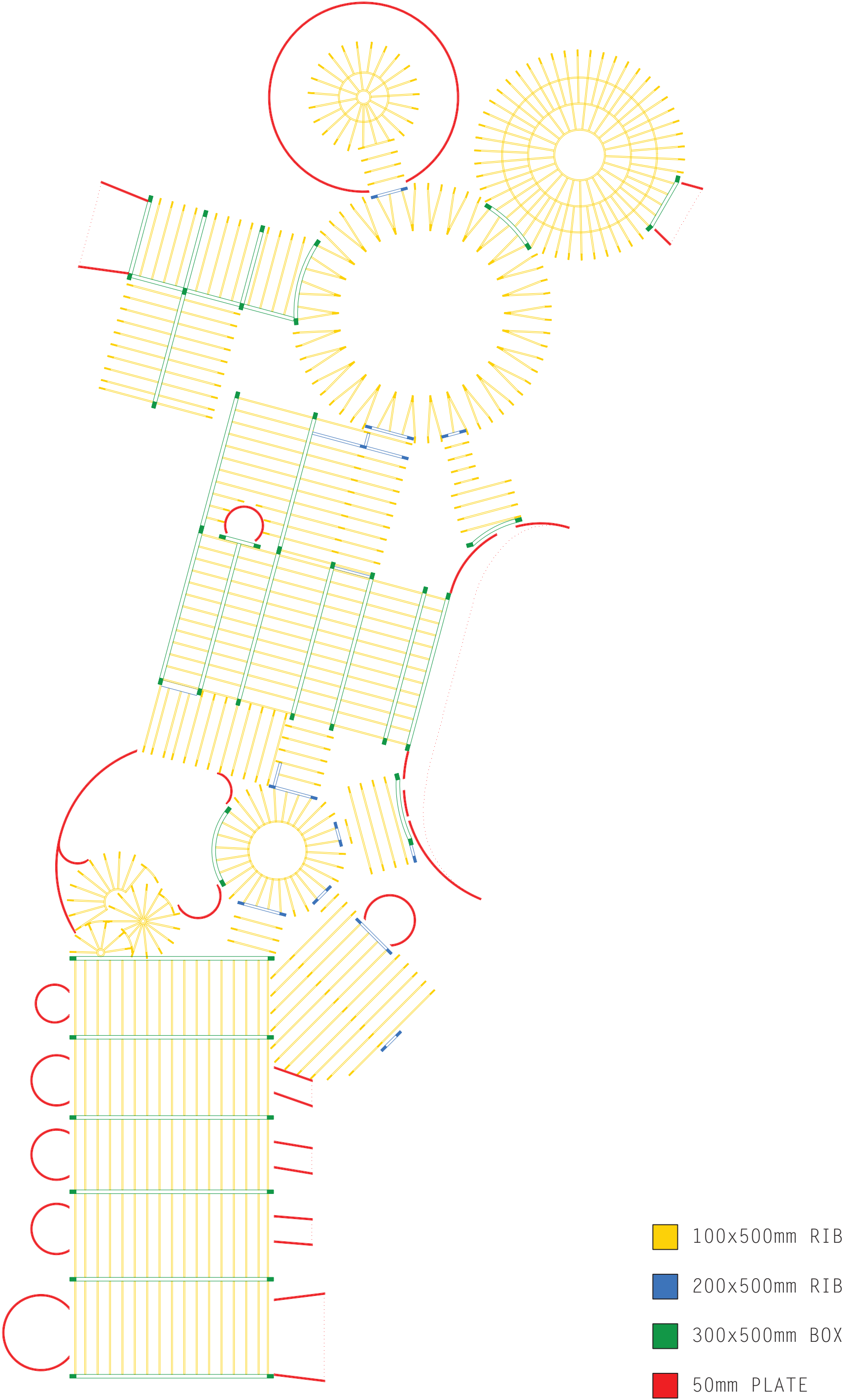

SCALE: 1/300
0 1 2 3 4 5 10m

CONNECTION DETAIL

Wherever the members are small enough, such as in the hallways, the entire rib would be fabricated as a closed loop. This would ensure optimal strength as the steel would be more continuous in a factory weld than in a site bolt-together connection.

When the members get to big to transport to site in one piece, the structure can be broken up into smaller pieces that are bolted together at connecting points. These are made of hollow steel box sections with a thickness at least that of the flange on the members being bolted. They have the threads welded on from the factory.

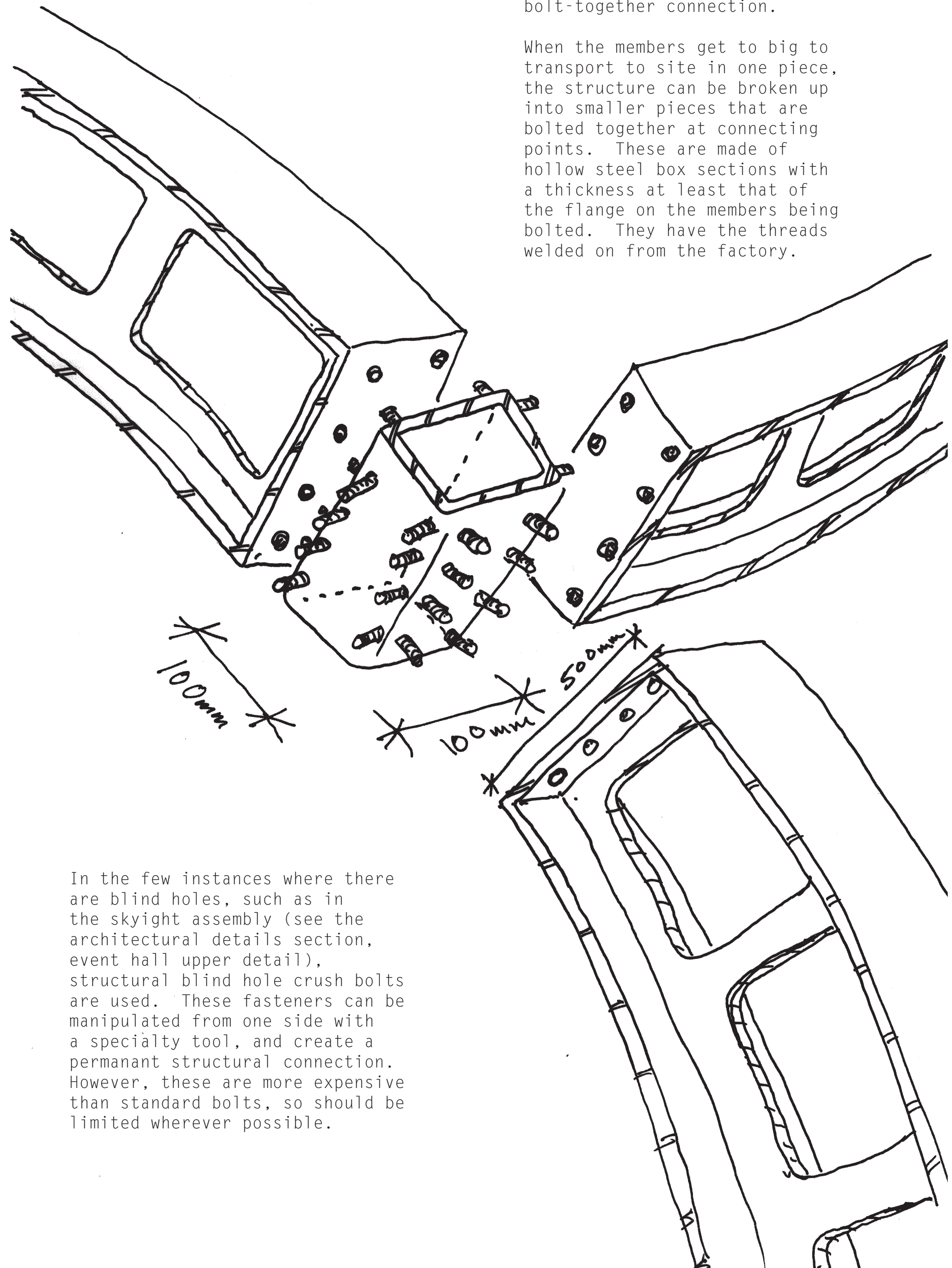

In the few instances where there are blind holes, such as in the skylight assembly (see the architectural details section, event hall upper detail), structural blind hole crush bolts are used. These fasteners can be manipulated from one side with a specialty tool, and create a permanent structural connection. However, these are more expensive than standard bolts, so should be limited wherever possible.

LOADING DIAGRAM AND LATERAL LOAD RESISTANCE

